

# Makin' Excavator 3D User Guide

Version 2.28



**MAKIN' 3D**  
**MACHINE CONTROL**

# Copyright and disclaimer

All rights reserved. No parts of this manual may be reproduced in any form without the express written permission of Makin AS (Makin). Makin makes no warranties, express or implied, with respect to this document or its contents. In addition, the contents of the document are subject to change without prior notice. Every precaution has been taken in the preparation of this manual. Nevertheless, Makin assumes no responsibility for errors or omissions or any damages resulting from the use of the information contained.

Copyright © 2019-2025 by Makin AS.

Contact the manufacturer:

Makin AS  
Vognvegen 23  
2072 Dal  
NORWAY

[www.Makin3D.com](http://www.Makin3D.com)

E-mail: [info@Makin3D.com](mailto:info@Makin3D.com)

Org. no. 920 323 650

# Table of contents

1. Introduction	8
1.1. Congratulations on your new product	8
1.2. Maintenance	8
1.3. Storage	8
1.4. Cleaning	8
2. Responsibility	9
2.1. Installation	9
2.2. Limitations	9
2.3. End-user license agreement	9
2.4. Warranty disclaimer	10
2.5. Software update	10
3. Product overview	11
3.1. Hardware Excavator 3D	11
3.2. Tablet buttons and light indicators (Panasonic FZ-A3)	12
3.3. Software	13
3.3.1. How to turn the system on	13
3.3.2. Elements of the work screen	13
3.3.3. Touch gestures	14
3.3.4. Symbols in the top bar	15
3.3.5. Shortcuts in the quick keys menu	16
Main menu	18
4. Project	19
4.1. Open or create a project	19
4.1.1. Create a secret project	21
4.2. Transfer files	22
4.2.1. Import to project	23
4.2.2. Export as-built	29
4.3. Supported file types	31
4.3.1. Project filter	32
4.4. References	34
4.4.1. Folders	36
4.4.2. Visible reference	38
4.4.3. Side reference	39

4.4.4. Height reference	39
4.4.5. Alert reference	39
4.4.6. As-built data	39
4.4.7. Lock Reference (line, point, or surface)	40
4.4.8. Dynamic 2D files	42
4.4.9. Copy Point	42
4.4.10. Stakeout	43
4.4.11. Create point from coordinate	49
4.4.12. Create line from points	51
4.4.13. Create profile along lines	52
4.4.14. Create surface	54
4.4.15. Edit Line	59
4.5. Fix point control	61
4.6. Geodetic systems	66
4.7. Extend surface	67
4.8. Plane	69
4.9. Temporary profile	70
4.10. Project offset	71
4.11. Change offset	73
5. Display	75
5.1. Labels	75
5.2. Use file color	76
5.3. Show maps	77
5.4. Show other systems	78
5.5. Show textures	79
5.6. Tool point coordinates	79
5.7. Machine speed	80
5.8. Auto hide quick keys	81
5.9. Reverse quick keys	81
5.10. Transparent surfaces	81
5.11. Dark theme	82
5.12. Wireframe	83
5.13. View settings	84
5.14. Change screen	85
6. Settings	87
6.1. Tolerances	87

6.1.1. Height tolerances	87
6.1.2. Side tolerances	90
6.1.3. Alert tolerances	92
6.2. Measure time	94
6.2.1. Measurement time	95
6.2.2. Delay time	96
6.3. Language	97
6.4. Length unit	97
6.5. Angle unit	98
6.6. Sound Volume	98
6.7. Area selection	99
6.8. Leveling meter	100
6.9. External buttons	101
7. Logging (As-built)	103
7.1. Log Point	104
7.2. Log Line	107
7.2.1. Log a new line from an existing line	110
7.3. Swift between logging points and lines	112
7.4. Own objects	113
7.5. Attributes	115
7.5.1. Custom attribute	117
7.6. Log offset	119
7.6.1. Edit a log offset	123
7.7. Photo	125
7.8. Create objects and attributes on Makin' Cloud	128
7.8.1. How to create objects	129
7.8.2. How to create attributes	133
7.8.3. Filter for overview	136
7.9. Object information and attributes	138
7.10. Sort as-built data	140
8. 2D functionalities	142
8.1. Main direction	142
8.2. Store position	143
8.3. Pickup position	143
8.4. Laser height	144
8.5. Auto laser height	144

9. GNSS	145
9.1. Correction source	145
9.1.1 Radio	147
9.1.2. NTRIP	151
10. Bucket	154
11. Chat	155
12. Status	156
13. Calibration	158
13.1. Bucket calibration	158
13.1.1. Tools required	158
13.1.2. Before calibrating the bucket	158
13.2. Bucket calibration menu	159
13.2.1. Bucket name	160
13.2.2. Bucket tilt and quick coupler	160
13.2.3. Bucket width	161
13.2.4. Bucket length	161
13.2.5. Bucket angle	162
13.2.6. Tilt offset	162
13.2.7. Profile angle	163
13.2.8. Flat angle	165
13.3. Check calibration of your excavator	166
14. Makin' Surfaces	167
14.1. Create and edit layers for Makin' Surfaces on the tablet	167
14.2. Change coloring from Reference height to Fixed	169
14.3. Hide the Makin' Surfaces layers	171
14.4. Enhance the display of the Makin' Surfaces layers	171
15. Troubleshooting	173
16. Appendix	174
16.1. Software updates	174
16.2. GNSS limitations	176
16.3. Frequency	177
16.4. Compliance information	178
16.5. Tablet connections	179
16.5.1. Tablet Panasonic FZ-A3 connections	179
16.5.2. Tablet Panasonic FZ-A2 connections	180
16.6. Docking station connections	181

<b>16.7. Tablet set-up</b>	<b>182</b>
<b>16.7.1. Tablet buttons and light indicators (Panasonic FZ-A2)</b>	<b>182</b>
<b>16.7.2. Programming the physical tablet buttons</b>	<b>183</b>
<b>16.8. Interface Box (IB-1)</b>	<b>184</b>
<b>16.9. Demo mode</b>	<b>185</b>
<b>16.10. Xbox controller</b>	<b>187</b>

# 1. Introduction

## 1.1. Congratulations on your new product

You are now ready to work more efficiently and keep the precision at an optimum level. Besides that, you will be more eco-friendly by doing the same amount of work in less time.

The system is designed to show you the information you need on the screen with the greatest accuracy.

At the construction site, you are the expert - Makin' 3D is the best work companion you can get.

We at Team Makin wish you all the best with the use of your new system.

## 1.2. Maintenance

It is recommended to check the system's accuracy regularly. We recommend that the operator of the machine frequently checks the positioning against a known point on every job site. See Chapter 13.3., **Check the calibration of your excavator.**

## 1.3. Storage

Keep the equipment safe when it's not installed in the machine. Use of a protective case is recommended if the tablet and antennas are removed from the machine to secure the devices from external stresses such as knocks and bumps.

## 1.4. Cleaning

The equipment must be cleaned regularly to ensure full functionality over time.

Cleaning is done by blowing to remove dust, you can also choose to use a damp cloth to wipe the tablet.

Under no circumstances should the equipment be high-pressure washed - neither inside nor outside the engine compartment.



## 2. Responsibility

### 2.1. Installation

All installation and main calibration of the system must be carried out by Makin approved technical personnel. Failure caused by unauthorized installation or repair could cause a void of warranty.

It is important to follow the machine manufacturer's instructions for installing the Makin machine control system to avoid violating any machine supplier's warranty regulations.

The user is responsible for using the product in accordance with the given instructions. The user is also responsible for ensuring that the reference models used are correct and that the bucket is properly calibrated and controlled.

Broken cables on the system may cause short circuits, system errors, and defective components. Ensure that no cables have external damage; damage must be repaired immediately before further use.

Errors in measurement results may occur if the equipment has been subjected to impact, abuse, modification, or transport damage. Control of the system after such events is important to ensure an optimum result.

Warranty: For further details, visit [www.Makin3D.com](http://www.Makin3D.com) for more information.

### 2.2. Limitations

The product is intended as a control tool, and any use beyond this is not permitted. The supplier or manufacturer cannot be held responsible for any use that goes beyond the given limits.

The Makin' excavator system is designed for utilization specifically on an excavator equipped with a standard bucket. The application of our system on an excavator featuring alternative attachments, such as hydraulic hammers or grapples, is not within the intended use of the Makin' excavator system. Such use falls outside the defined scope, and Makin cannot be held accountable for any instances exceeding the specified limits.

### 2.3. End-user license agreement

License: The system is preloaded with software, which can also be downloaded with permission from Makin. The software is protected by copyright and other laws. The use of the software is governed by the license agreement entered into with the Makin' 3D system when purchasing the product.

For further legal terms and conditions, including but not limited to the applicable End User License Agreement between you and Makin, we refer you to visit Makin's website, [www.Makin3D.com](http://www.Makin3D.com).

## **2.4. Warranty disclaimer**

Makin provides this documentation without warranty, term, or condition of any kind, either implied or expressed, including, but not limited to, the implied warranties, terms, or conditions of merchantability, satisfactory quality, and fitness for a particular purpose.

Makin, its employees, and agents will not be responsible for any loss, however arising, from the use of, or reliance on this information.

For further legal terms and conditions, including but not limited to the applicable End User License Agreement between you and Makin, we refer you to visit Makin's website, [www.Makin3D.com](http://www.Makin3D.com).

## **2.5. Software update**

Software will be automatically and frequently updated, and users will get a notification on the screen. Software updates require a valid maintenance license. To start downloading an updated software version, users will be asked to agree before the download starts.

# 3. Product overview

## 3.1. Hardware Excavator 3D

### Hardware overview

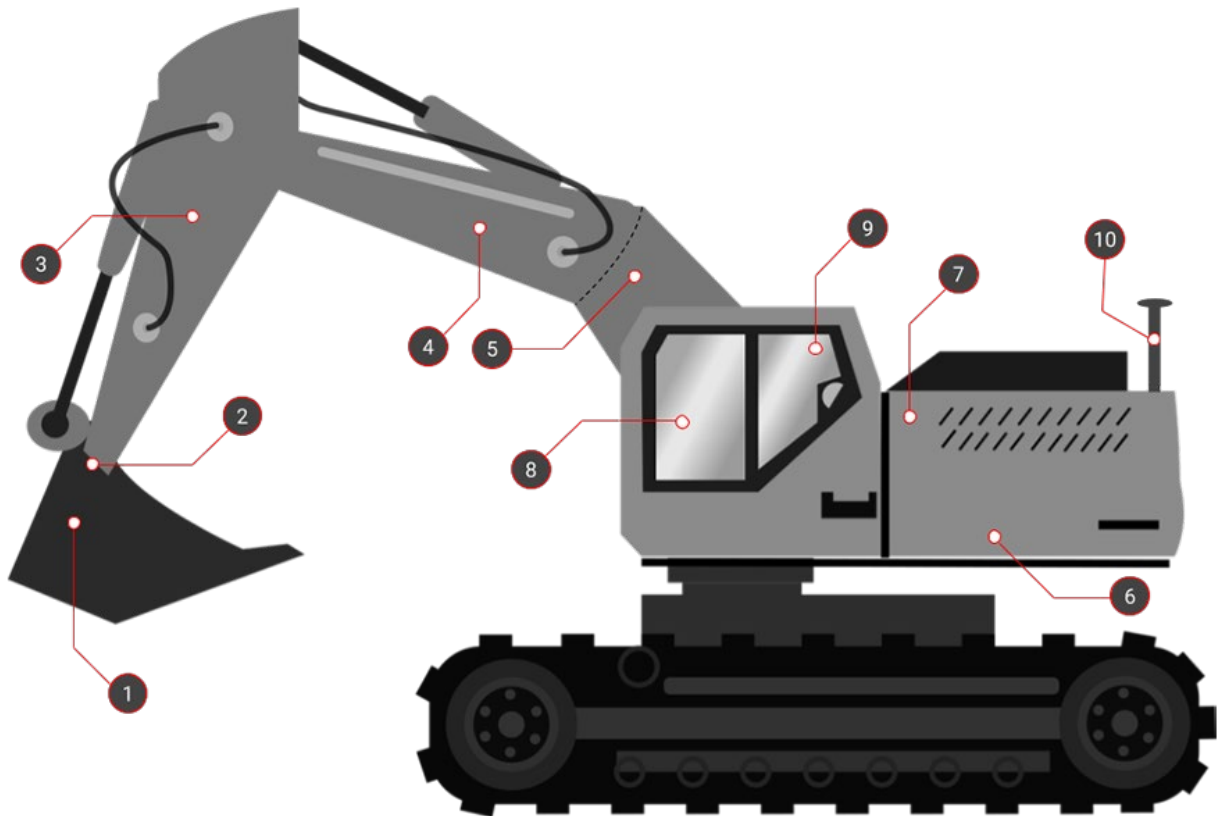

1. Bucket sensor

2. Tilt sensor for sideways bucket angle.  
360-degree tilt-rotator (Optional)

3. Stick angle sensor

4. Boom height sensor

5. City boom sensor (Optional)

6. Machine sloping sensors

7. Interface Box for system power and  
data communication

8. Tablet w. machine control software

9. GNSS receiver

10. GNSS antenna

### 3.2. Tablet buttons and light indicators (Panasonic FZ-A3)



1. On/Off button

2. Volume up

3. Volume down

4. Quick access to tablet's menu

5. Not in use. The button can be programmed ([more](#) info below).

6. Not in use. The button can be programmed (more info below).

Additionally, screenshots can be taken by pressing the '**On/Off button**' and '**Volume down**' (simultaneously holding down buttons 1 and 3 for about two seconds). This can be useful in the unfortunate case where assistance is required. Find the screenshots via the '**Photos**' app.

## 3.3. Software

### 3.3.1. How to turn the system on

- 1) Turn on your Makin' 3D system by pressing the on/off button on the tablet. Android will start up and present the 'Lock screen'.
- 2) Swipe upwards with one finger on the touchscreen to access Makin' 3D.
- 3) If no project has been previously loaded, you will be prompted to do so. See Chapter 4.1., **Open or create a project.**

### 3.3.2. Elements of the work screen

Makin' 3D offers a variety of screens to choose from. Below is a description of one that includes most of the available visual features.

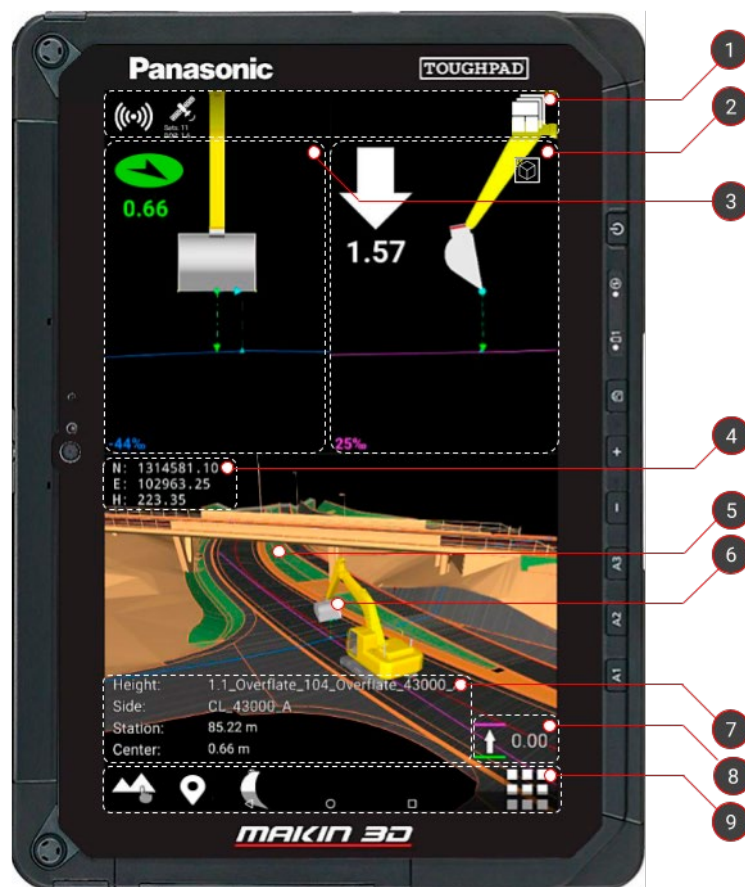

1. Top bar with status indicators for connectivity. It also contains features for resetting the pan and zoom level as well as changing between screens.
2. Indication of the slope in the main direction of the tool point. The arrow indicates the vertical distance to the selected height reference. The arrow will change color depending on the distance to the target. Tap the indicator to change the height tolerances.
3. Indication of the slope in the cross direction of the tool point. The arrow indicates the horizontal distance to the selected side reference. The arrow will change color depending on the distance to the target. Tap the indicator to change the side distance tolerances.
4. Info bar for Easting, Northing and Height coordinates.
5. Tap any element in the loaded 3D model to bring up the References dialog.
6. Tap the bucket (also in the static views) to change or calibrate the machine's bucket.
7. *Station*: Indicate where on the centerline you are located. To the right of the Station, you can see the slope along the road  
  
*CL*: Distance to centerline. To the right of the CL, you can see the slope across the road.  
  
*Height*: Name of current Height Reference  
  
*Side*: Name of the current Side Reference.
8. Change the height offset according to the current reference - e.g. the specified plane or the loaded model file.
9. Quick keys are shortcuts to features found in the menu.

### 3.3.3. Touch gestures

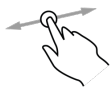

Use one finger to rotate a 3D View.



Use two fingers to pan a Top View or 3D View.



Spread or pinch two fingers to respectively zoom in or out of a Top View or 3D View.



Tap to select.



Sometimes it is possible to long-press for further options.

### 3.3.4. Symbols in the top bar



Indicating a connection to the internet. The symbol appears white when a connection is established and gray if there is no connection.



Indicates the number of visible satellites. hRMS (Horizontal Root Mean Square) and vRMS (Vertical Root Mean Square) indicate the current GNSS accuracy. Tapping the icon will bring you to the GNSS status menu.



Indication of synchronization of data between server and machine.



An indication that you have remote support from Makin.

This will usually be in connection with a remote support case where you will be notified.



Bring your machine back to the center of your screen after zooming and panning.



Placed in the upper right corner. Tap for a change of screen, depending on the work you are doing and what you want to have in focus.



Toggles between 2D (top view) and 3D view. This button is always placed on the work screen that it toggles.



Indicating project offset. The symbol appears when a project offset is applied to the active project.



The tablet is connected to the cloud.



Synchronize to the cloud.



The tablet is not connected to the cloud.



The tablet is disconnected to the cloud because of a secret project.

### 3.3.5. Shortcuts in the quick keys menu



Tap to access the 'References' dialog. Another way to access this dialog is to select an element in the 3D model. Long hold to access the 'Project' menu.



Log point. The name of the current object is shown on the icon's label. Tap to quickly log a point, which will be stored alongside general as-built data. Long hold to access objects. You need to select an object before logging a point. You can add an as-built photo to the point.



Log line. Start logging a line by adding line log points. You can select a line and edit it. Select it as a Point of Interest (POI), name it, and add a comment to it. You can also edit the line point's offset. You need to select an object before logging a line.



Disable log line. Stops the line logging.





Both the width and name of the bucket are shown on the icon's label. Tap to access the 'Bucket' dialog.

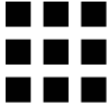

Menu from where you can access all features of the system.



Copies a point that you are then allowed to edit.



Stakeout for both points, lines, and line points.



Makin' Surfaces is active. The name of the layer will be shown here.

# Main menu

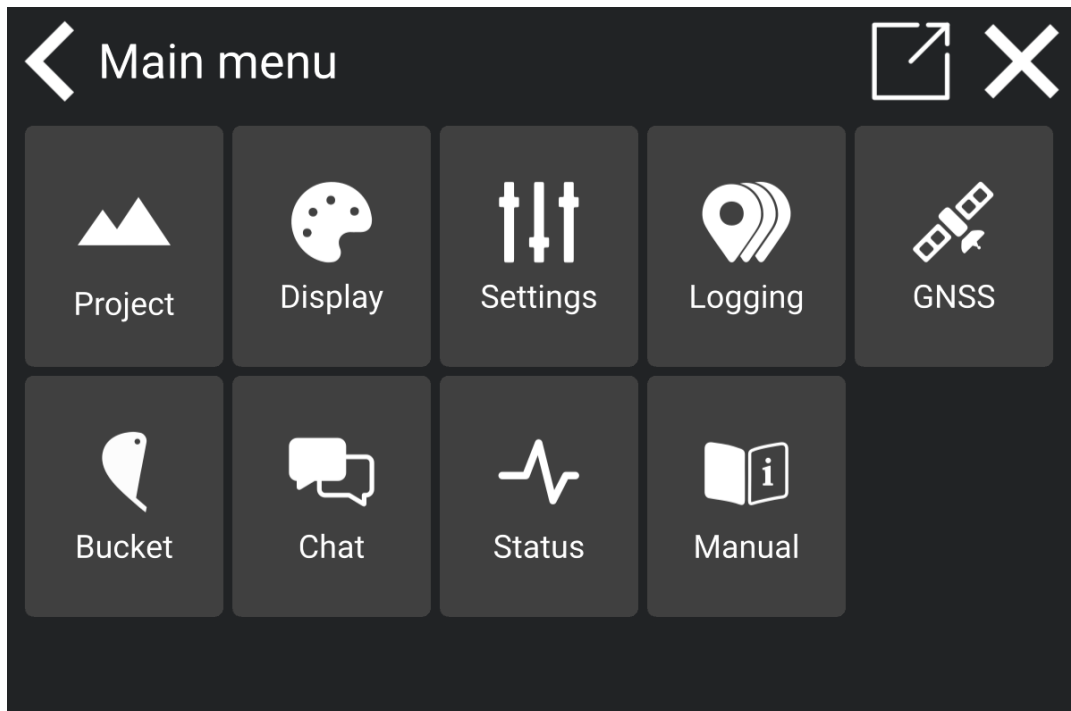

# 4. Project

Menu > Project

Working according to any kind of design is considered a project, whether it is a simple relative plane or referencing lines and surfaces in more complex 3D models.

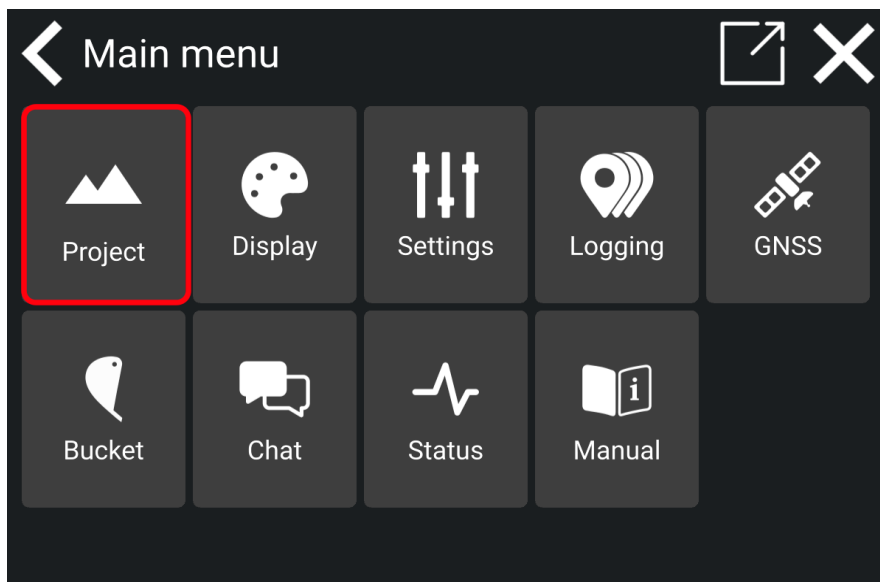

## 4.1. Open or create a project

Menu > Project > Open project

To open an existing project:

- 1) In 'Project' tap 'Open project' to see all the projects stored. This dialog is automatically opened if no project is loaded.

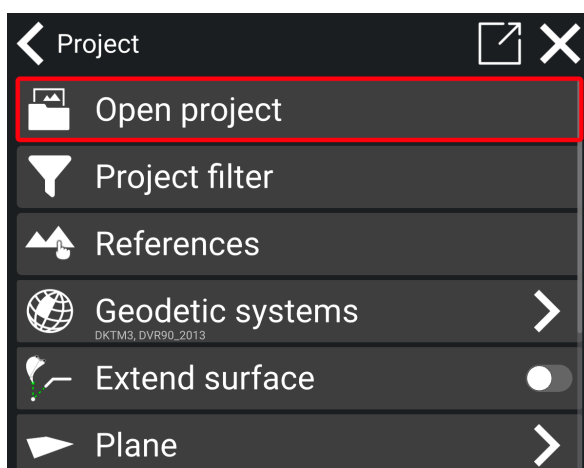

2) Tap on the project you want to open, and the download starts.

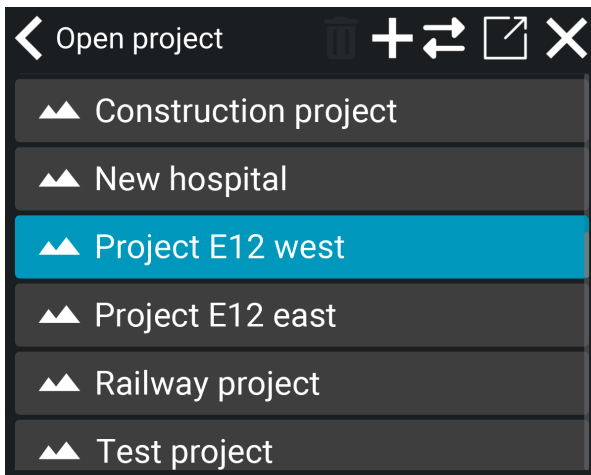

3) If you want to create your own local project, tap the '+' icon.

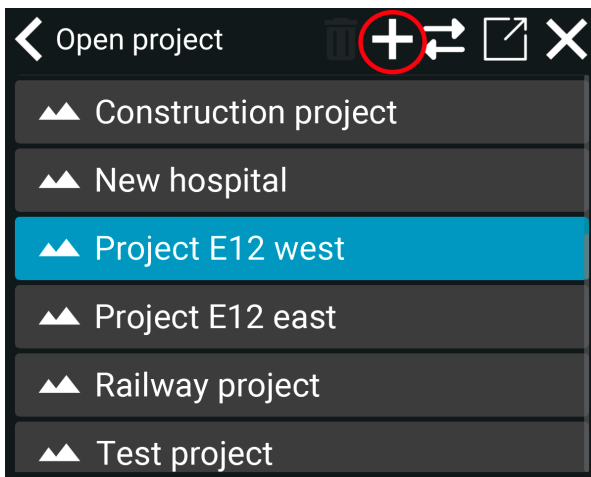

4) Tap on the **local project** icon.

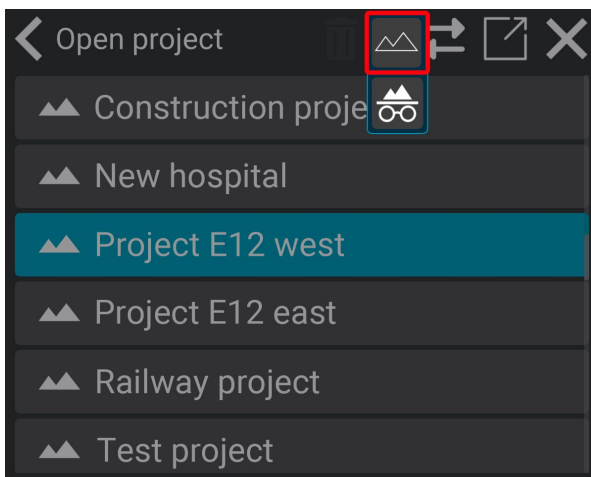

### 4.1.1. Create a secret project

You can create a secret project that will only be available on your tablet and will not synchronize to the Makin' Cloud. Secret projects are useful for construction projects needing confidentiality due to security, critical infrastructure, or competitive advantages.

- 1) Go to **project > Open project**.
- 2) Tap on the '+'-symbol.
- 3) Tap on the '**secret project**' icon.

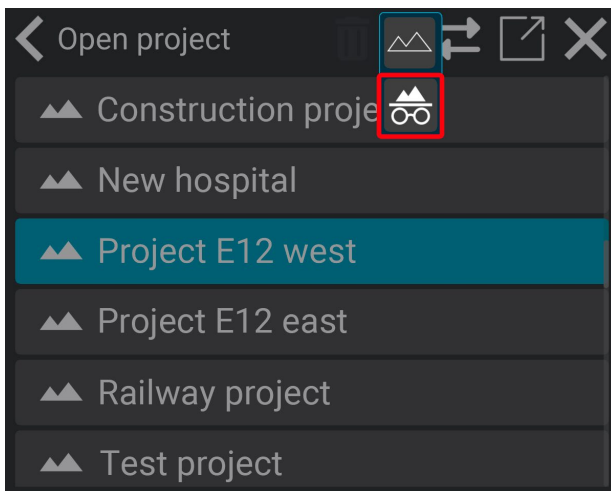

- 4) Name the secret project.

The icon in front of the project name indicates that it is a secret project:

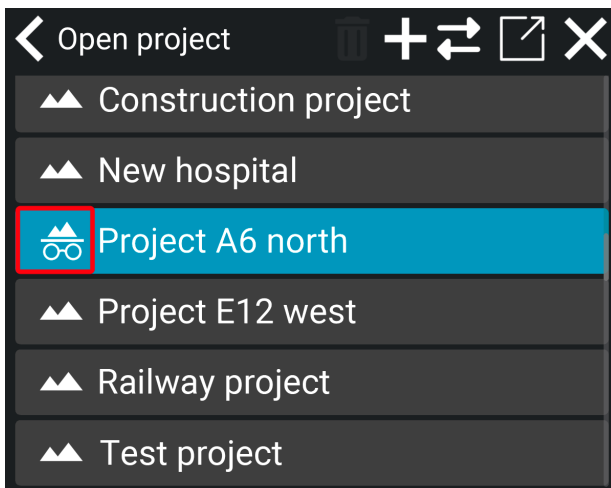

#### 4.1.1.1. Remote control for secret projects

If you need support while working on a secret project, you must grant support access to your tablet during remote control. The secret project is disconnected and does not synchronize with the Makin' Cloud, as indicated by this icon:



The support staff can see that your system is online on the Makin' Cloud, but they will not have access to any details about the secret project. To get support while working on a secret project, you need to give access to the support staff. When the support staff initiates remote control, a notification will pop up on your tablet:

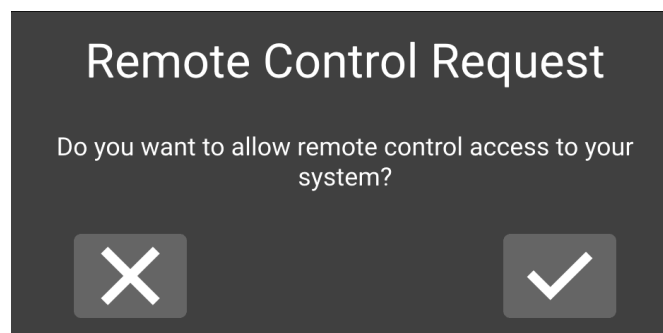

To allow remote control access, tap on the check mark.

## 4.2. Transfer files

You can transfer files via USB flash drive to secret projects, local projects and cloud projects. You can import files to the project and export as-built data from the project. *Please note:* If you import files to a local project or a cloud project, those files will be available on Makin' Cloud. For more details, see section 4.2.1.1., **Imported files on Makin' Cloud**.

- 1) Tap on the 'transfer files' icon.

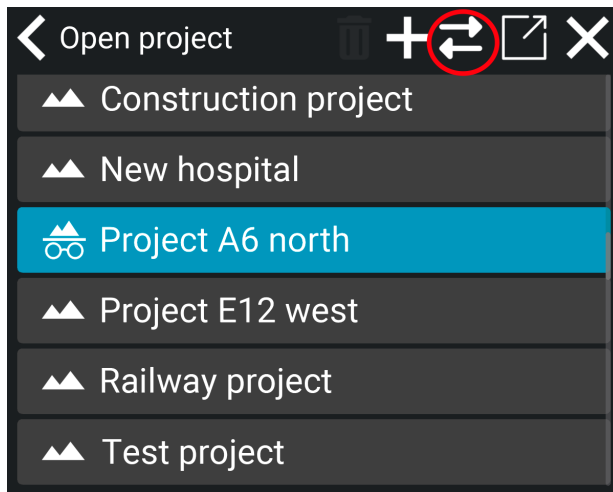

- 2) Choose between **import to project** or **export as-built** data from the project. Learn more about importing and exporting in the sections below.

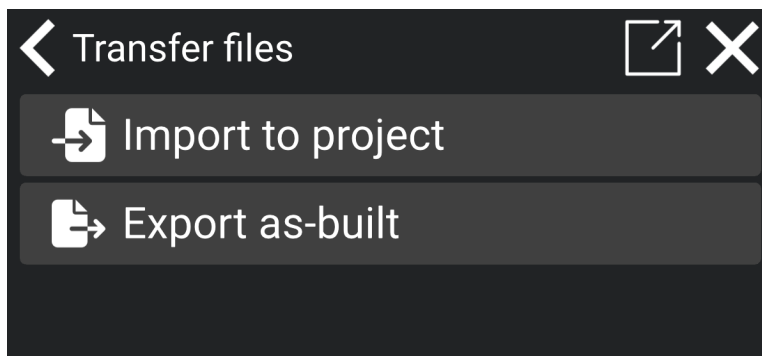

### 4.2.1. Import to project

You can import files to the project via a USB flash drive. You cannot import single files but only folders from the USB flash drive. *Please note:* If you import a file with the exact same name as an existing file in the project, the new file will overwrite the existing one.

#### How to import files to the project:

- 1) Important: Insert the USB flash drive into the tablet first.
- 2) Tap on '**Import to project**'.

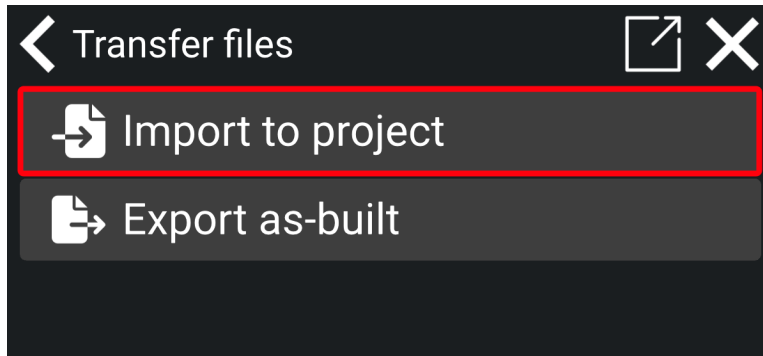

- 3) You will now be directed to Android's dialog.
- 4) The first time you insert the USB flash drive you need to make sure that the USB flash drive is selected. Tap on the 'three stripes' icon in the top left corner.

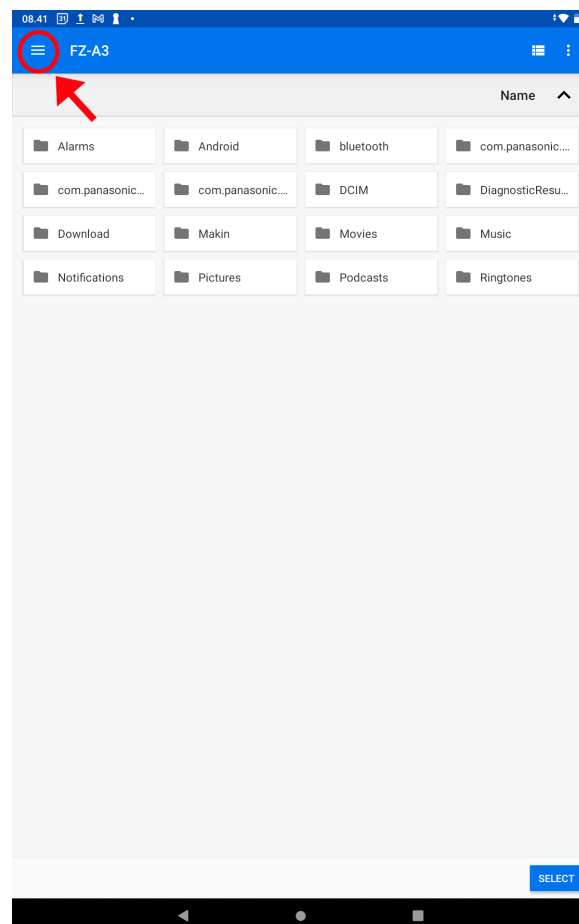

- 5) Tap on the name of the USB flash drive to open it.



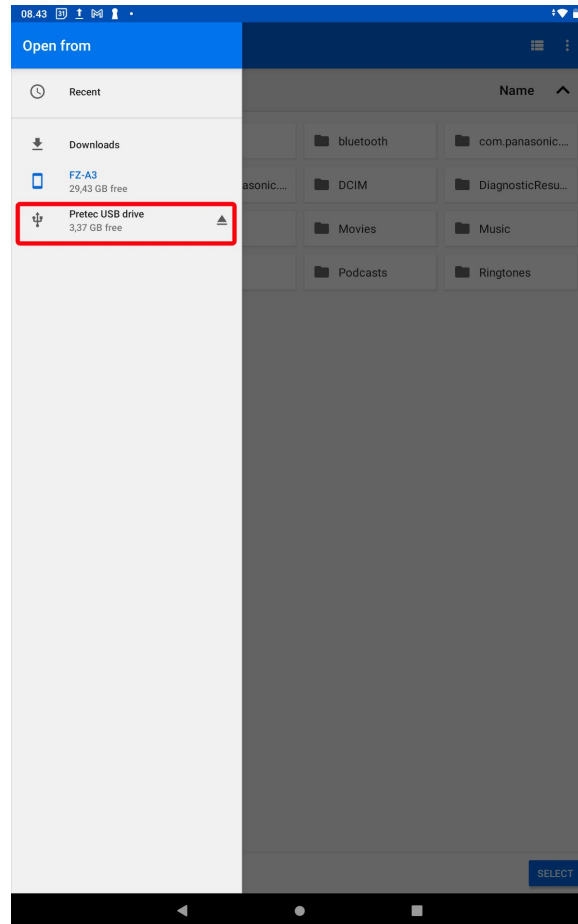

6) Tap on the folder you want to import files from.

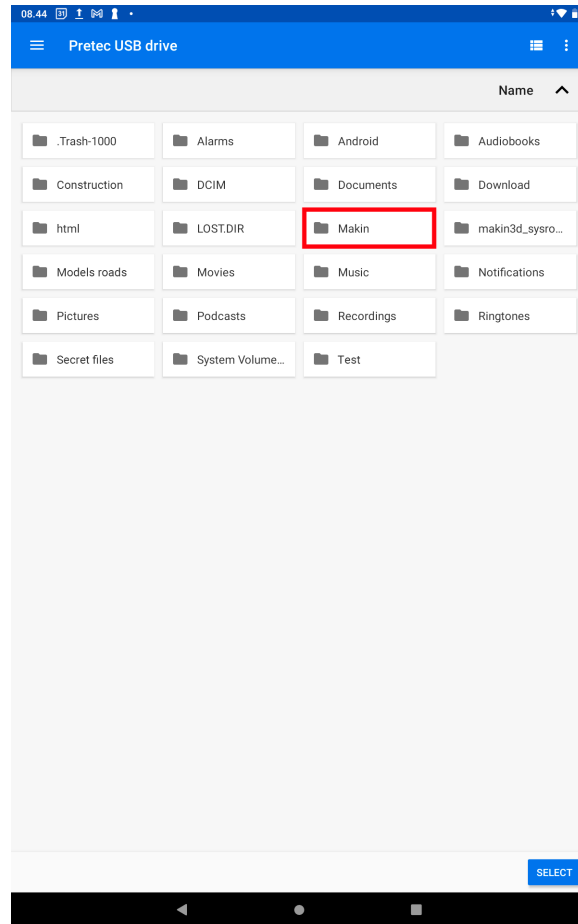

- 7) Tap on '**select**'. *Please note:* All the files in the folder will be imported. You cannot import single files.

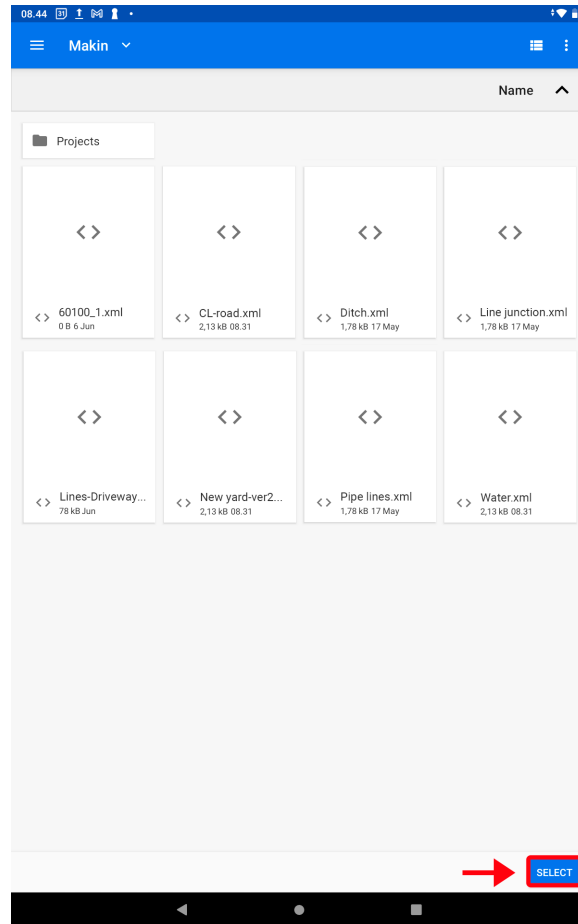

- 8) Import of files is completed. You can view the files under **Project > References**. The imported files will be marked with a \*.

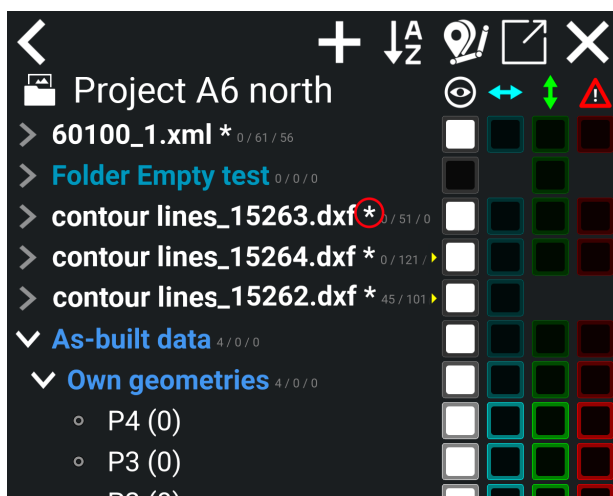

### 4.2.1.1. Imported files on Makin' Cloud

When you import files to a local or cloud project, they will be available on Makin' Cloud. However, these files will be stored in your system's project folder, and not as part of a global project within your organization.

#### How to find imported files on Makin' Cloud:

- 1) Go to **Makin' Cloud > Choose organization > Systems**

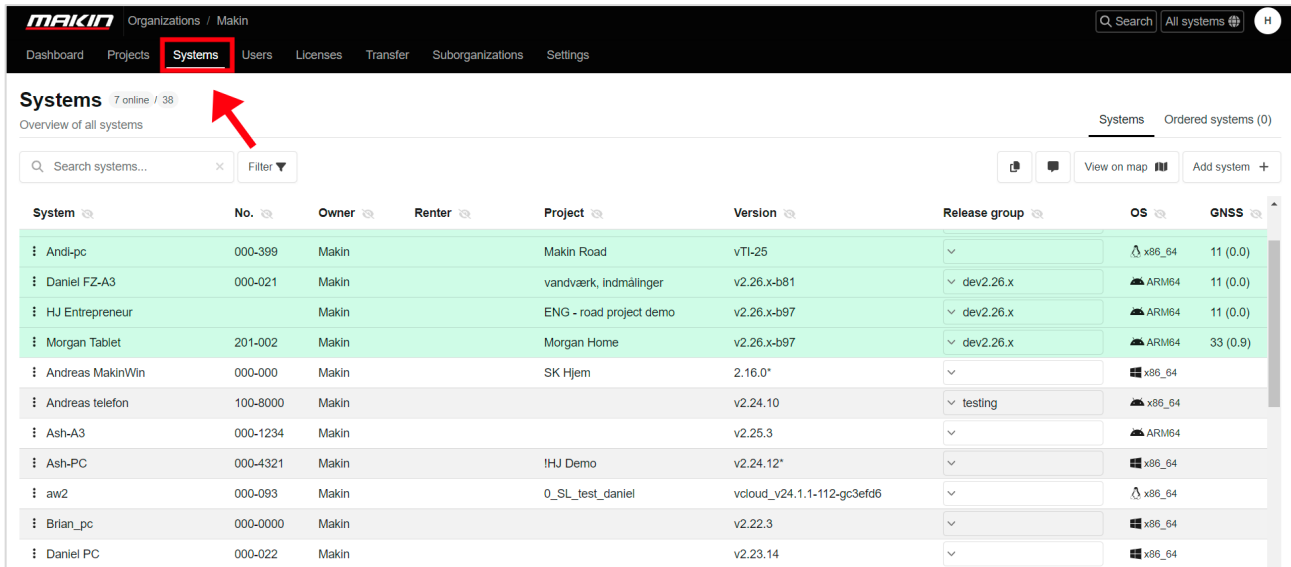

System	No.	Owner	Renter	Project	Version	Release group	OS	GNSS
Andi-pc	000-399	Makin		Makin Road	vTI-25		x86_64	11 (0,0)
Daniel FZ-A3	000-021	Makin		vandværk, indmålinger	v2.26.x-b81	dev2.26.x	ARM64	11 (0,0)
HJ Entrepreneur		Makin		ENG - road project demo	v2.26.x-b97	dev2.26.x	ARM64	11 (0,0)
Morgan Tablet	201-002	Makin		Morgan Home	v2.26.x-b97	dev2.26.x	ARM64	33 (0,9)
Andreas MakinWin	000-000	Makin		SK Hjem	2.16.0*		x86_64	
Andreas telefon	100-8000	Makin			v2.24.10	testing	x86_64	
Ash-A3	000-1234	Makin			v2.25.3		ARM64	
Ash-PC	000-4321	Makin		!HJ Demo	v2.24.12*		x86_64	
aw2	000-093	Makin		0_SL_test_daniel	vcloud_v24.1.1-112-gc3efd6		x86_64	
Brian_pc	000-0000	Makin			v2.22.3		x86_64	
Daniel PC	000-022	Makin			v2.23.14		x86_64	

- 2) Select the system that imported the files.

- 3) Open the **project folder** under that system.

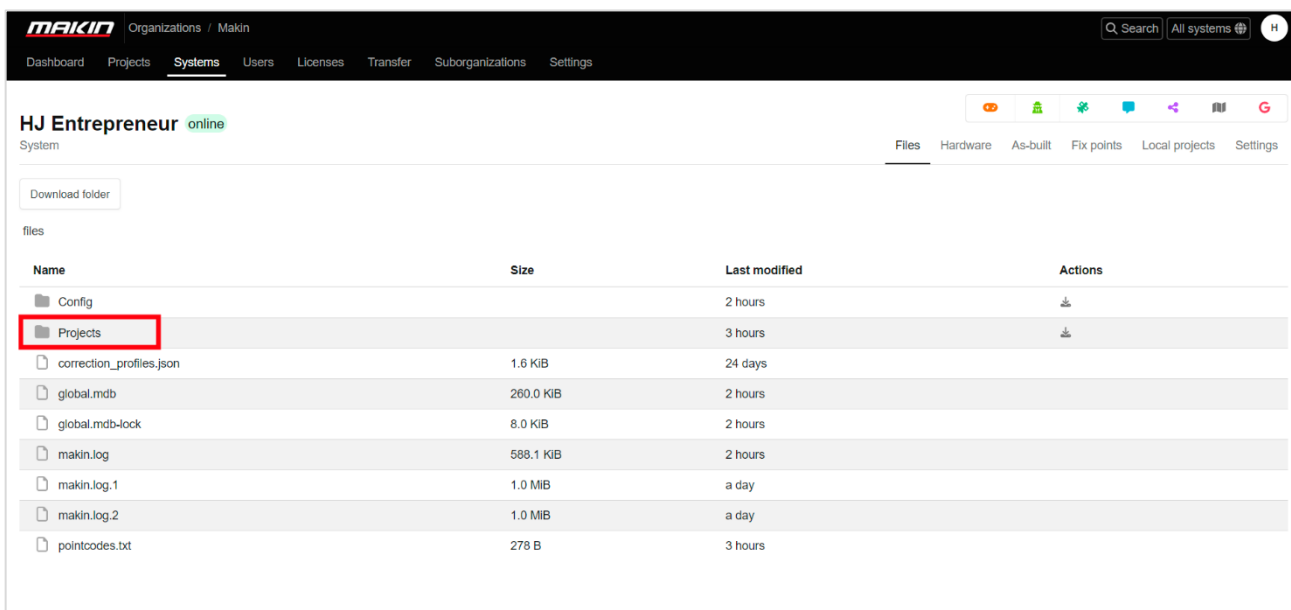

Name	Size	Last modified	Actions
Config		2 hours	Download
Projects		3 hours	Download
correction_profiles.json	1.6 KiB	24 days	Download
global.mdb	260.0 KiB	2 hours	Download
global.mdb-Jock	8.0 KiB	2 hours	Download
makin.log	588.1 KiB	2 hours	Download
makin.log.1	1.0 MiB	a day	Download
makin.log.2	1.0 MiB	a day	Download
pointcodes.txt	278 B	3 hours	Download

4) Select the **project** where the files were imported.

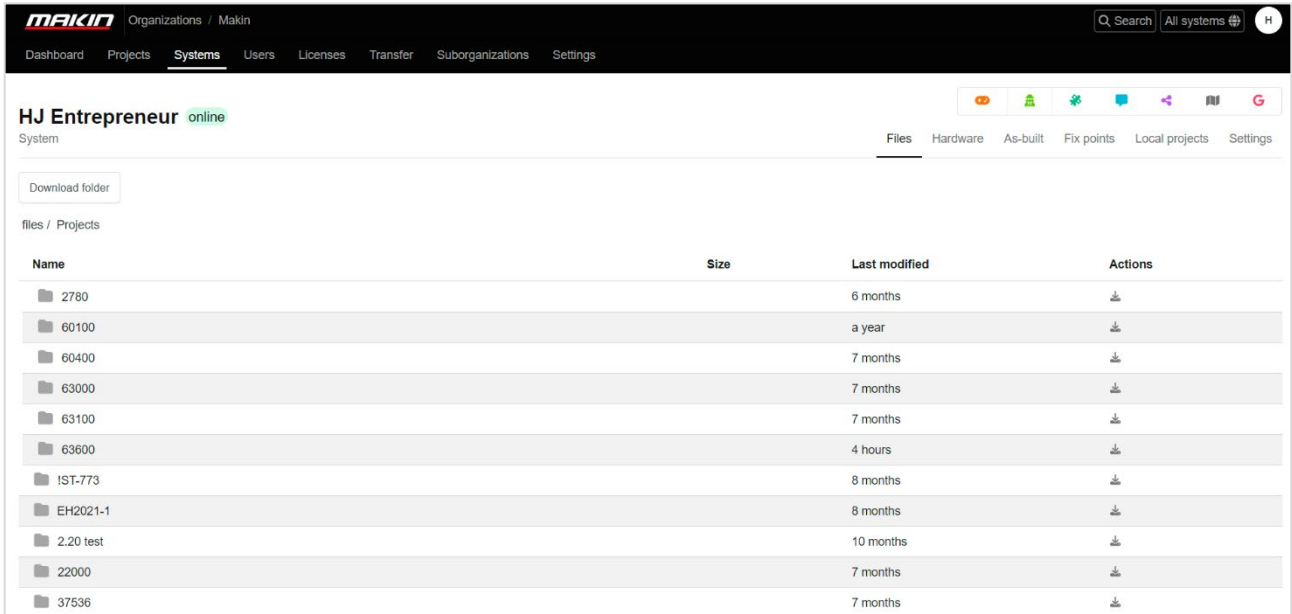

5) The imported files will be available in this folder.

## 4.2.2. Export as-built

You can export as-built data from the project to a USB flash drive. The as-built data will be exported as XML files.

- 1) Important: Insert the USB flash drive into the tablet first.
- 2) Tap on '**Export as-built**'.

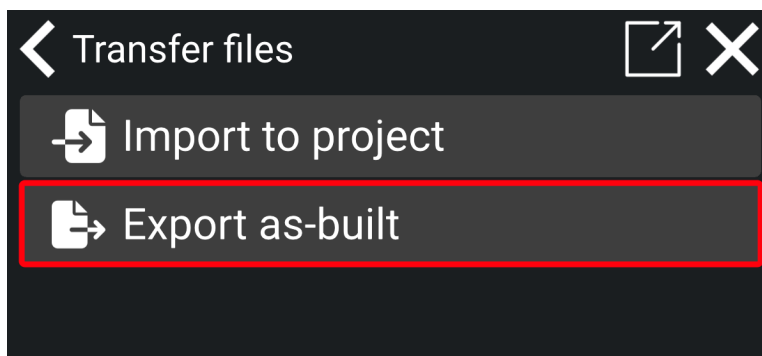

- 3) You will now be directed to Android's dialog.
- 4) Make sure that the USB flash drive is selected. If not, tap on the 'three stripes' icon in the top left corner and select the USB flash drive.

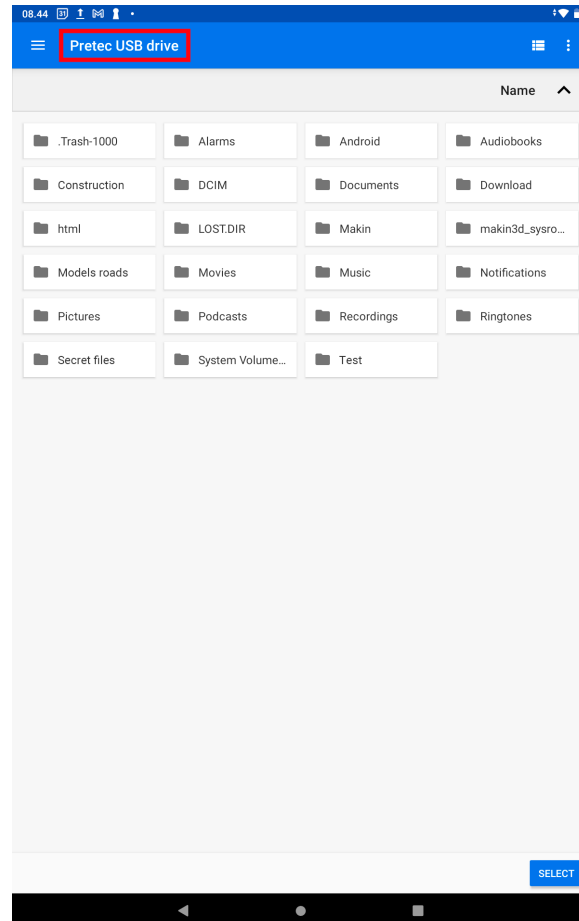

- 5) Tap on the folder where you want to save the as-built data.
- 6) Tap on '**Select**'. This will export the project's as-built data to the chosen folder.

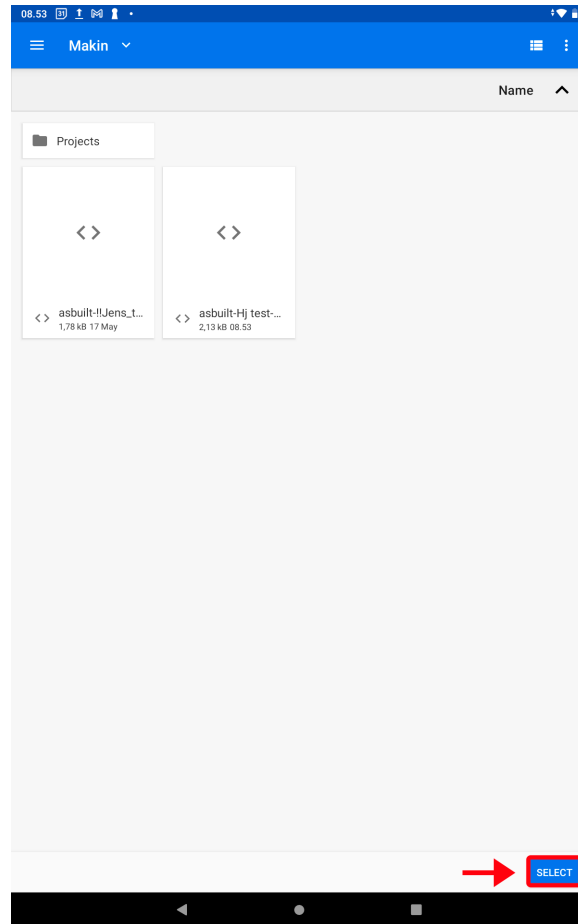

7) The project's as-built data is now saved in the selected folder on the USB flash drive.

### 4.3. Supported file types

When creating a project, the following file types are supported:

- LandXML Roadrunner format (XML)
- Drawing eXchange Format (DXF)
- Norwegian coordinate and observation format (KOF)

New projects are stored in LandXML format.

### 4.3.1. Project filter

*Note: When Makin' 3D reaches 170 MB data in size, a warning will pop up, informing you that the project is large. This can reduce performance. The file size depends on the complexity and the details in the model.*

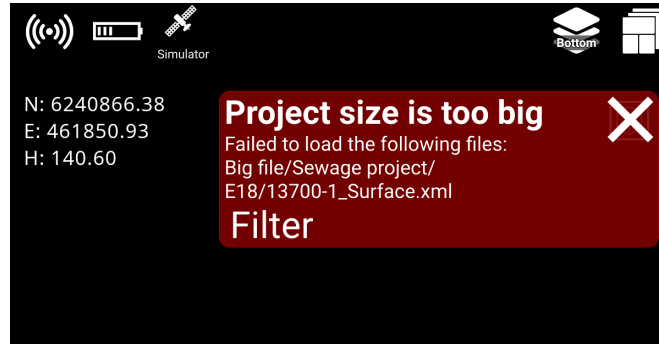

If the project reaches 170 MB data in size, part of the model will be shown on your tablet screen near the application, while the rest remains hidden. As you move the application around, the visible part of the model will adjust to stay aligned with where your application is.

You can choose to load a part of the project file under **Project > Project filter** or click '**Filter**' in the notification (see picture above).

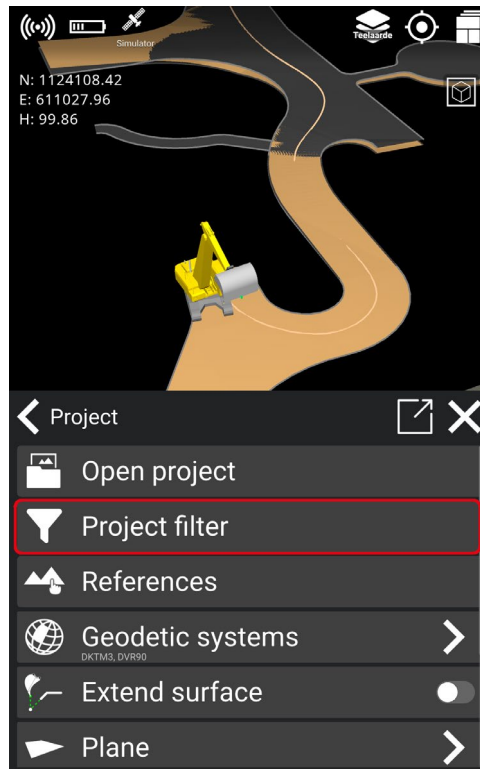



- 1) Select the folder you want to activate and load by clicking on the button. When the folder is activated, the button will turn blue.

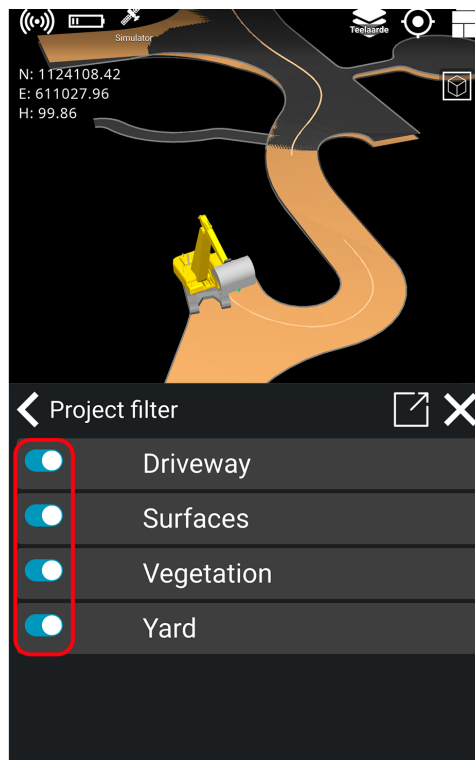

- 2) Deselect the folders you do not want to load by clicking on the button in front of the folder's name. When deselecting the folder, the button will turn off.

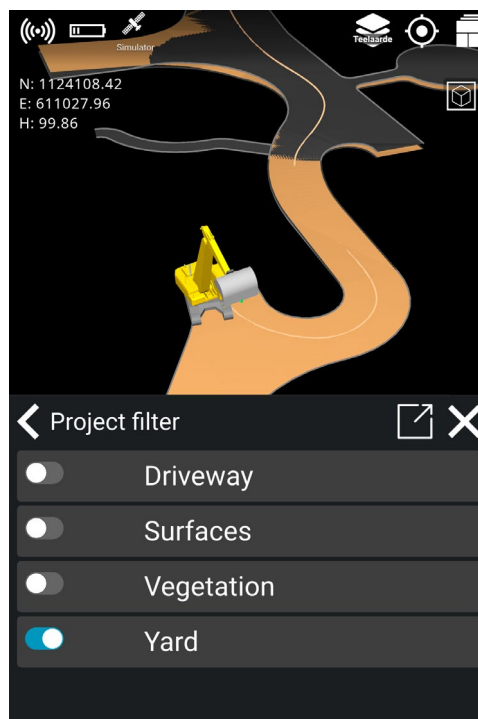

The activated folders will be loaded and displayed under 'References' in a petrol blue color, along with the files from the folders.

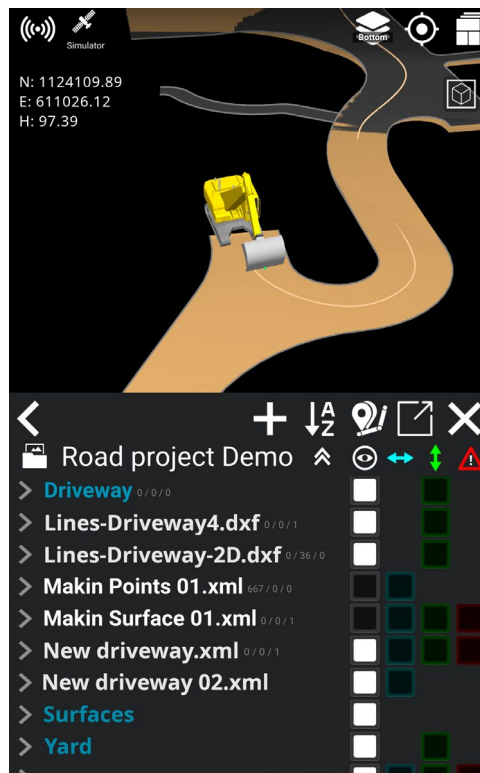

You can create folders on Makin' Cloud and then drag your project files into these folders: **Makin' Cloud > Project > Choose your project > New folder.**

## 4.4. References

**Menu > Project > References**

In the 'References' dialog, you can choose which part of the 3D model should be active/inactive and what should be selected as height references, side references, and alert references.

Height references can be points, lines, and surfaces.

Side- and alert references can be points and lines.



1. Tap one of the symbols to select all elements in the project

2. White means an element is visible and activated

3. Blue indicates an element used as a side reference. Press to select as reference. Long press will deselect all other side references selected

4. Green is used for elements that may reference the height. Press to select as reference. Long press will deselect all other height references selected

5. Red is an alert reference, which gives a warning when the tool is too close to the element. Not applicable for surfaces.

6. Highlight elements with yellow color in the 3D model

As an alternative to going via the menu, you can also find this feature in the **Quick Keys menu** or by selecting any element in the 3D model.

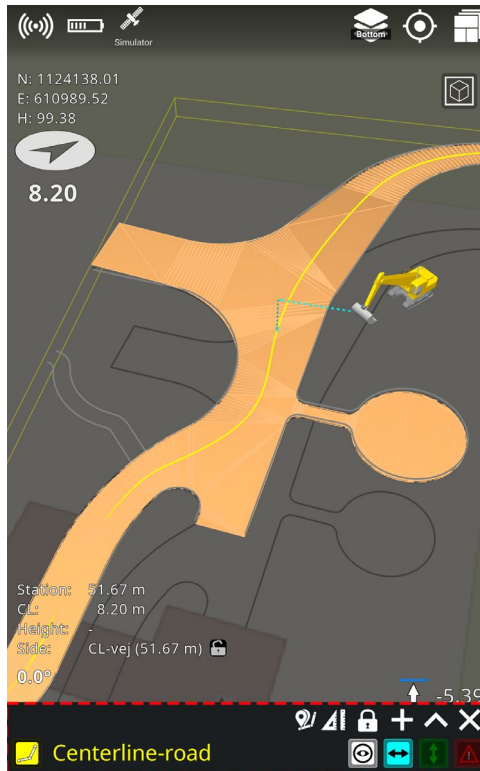

#### 4.4.1. Folders

In the reference examples below, we see all the data that has been entered on a road parcel.

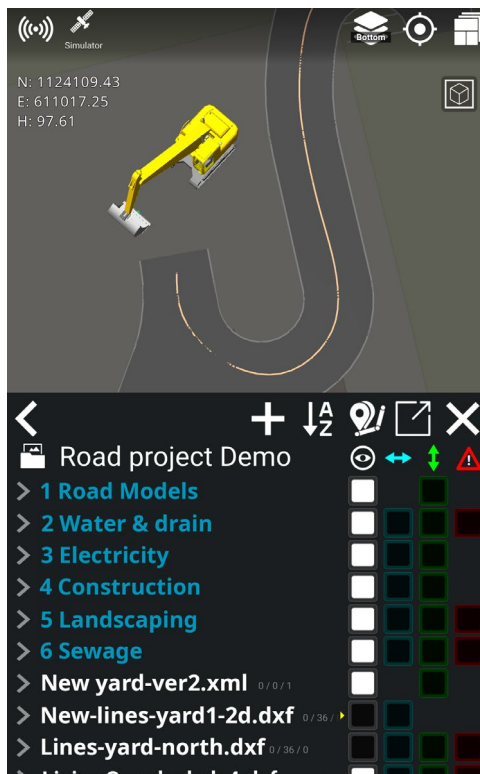

In this example, we have six folders:

- Road Models
- Water & drain
- Electricity
- Construction
- Landscaping
- Sewage

If you enable options (i.e., set visible, side reference, height reference, alert reference) for a folder, you enable the option for all models in the entire folder. For example, if you have many road models, you may want to open the folder with the small gray arrow to the left of the folder and only activate the road models that you need.

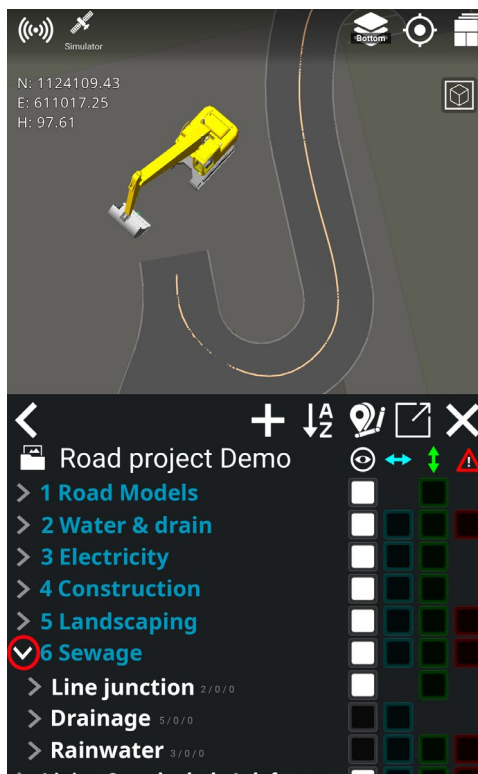

Folders are shown in blue text - model files are white. File and folder names are scrollable, indicated with a tiny yellow arrow to the right of their names. A star following a project name indicates the project is local.

In the above example, we have opened the folder for road models, which contains several individual files. You can turn on all elements of a folder or turn on some details by expanding individual folders.

Within the folders, you can select specific data to make visible and choose what to actively work against.

To get an indication of the different model files, side and/or height must be activated. As with viewing, you do this by tapping the respective blue and/or green boxes. By enabling visibility, side, and height in combinations, you can customize what information you want on the screen.

#### 4.4.2. Visible reference

All geometries are visible by default and can be hidden by deselecting the white square next to them, beneath the eye symbol. Calculations are only performed according to visible layers.

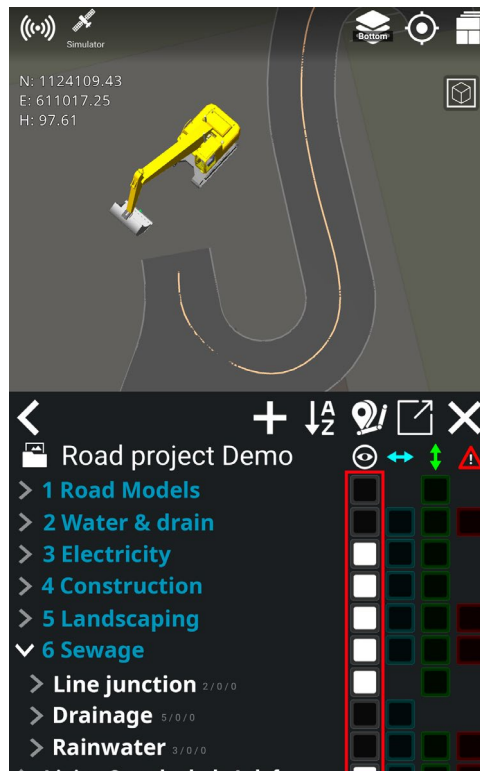

For example, if we want to make all roads visible in a group of models, simply check the white box to the right of its folder. It will make all roads visible on the screen. If we only want to see one road, just activate the white box to the right of the particular road file.

### 4.4.3. Side reference

Side references are geometries used for side calculations. When models are activated, they have a blue color next to them, beneath the symbol with the horizontal arrow in the 'Reference' dialog. The closest geometry, activated for side reference, will automatically be used. Lines and points can be selected as side references - not surfaces. The calculated side distance is the horizontal distance to the geometry.

### 4.4.4. Height reference

Height references are geometries used for height calculations. They are indicated with a light green color when activated in the 'References' dialog, beneath the vertical arrow symbol. The lowest geometry, with height reference enabled, will automatically be used. Height references are typically surfaces, but lines and points can also be selected for height calculations.

### 4.4.5. Alert reference

Alert references are geometries used for alert calculation. The closest geometry activated as an alert reference with a red square beneath the warning symbol will automatically be used. Lines and points can be selected as alert references - not surfaces. Unlike the calculation of side reference, the calculated alert distance is the closest Euclidean distance (shortest path) to the geometry.

### 4.4.6. As-built data

#### **Menu > Project > References**

As-built data is data used for documentation of the performed task. As-built data can be used in different ways: to document that the project is built the same way as it was originally designed or to document if extra work has been performed, e.g., how much soil is being removed from an area.

The as-built data is collected when the machine works, and the data is logged by the operator. These data can be used later in the process to assure the quality of the project and/or to calculate the volume of material that is added or removed from an area. As-built points will be saved in the overview if it is necessary to navigate to the points at a later stage of the project.

As-built data can be used as references in a similar way as other references. The green points are your own points, and the purple points are points from other applications. The lines and points are continuously saved and synchronized to the Makin' Cloud, where they can be downloaded as .CSV, .KOF or .XML formats.

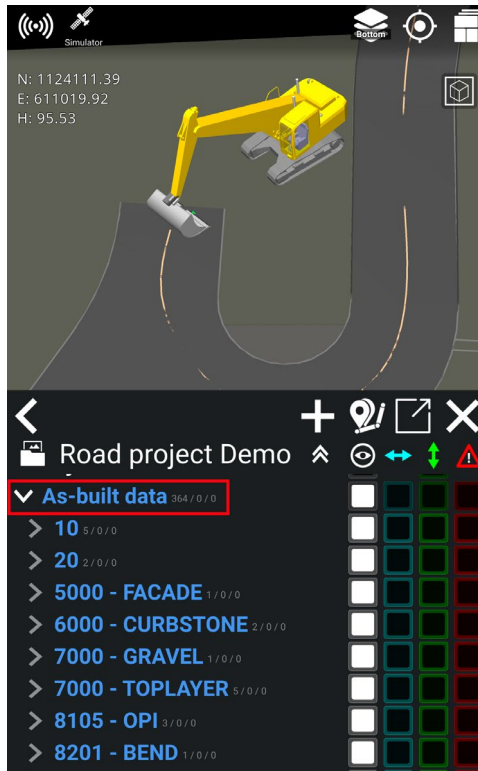

#### 4.4.7. Lock Reference (line, point, or surface)

Makin can work with multiple active references at the same time. This allows the user to activate and work with the references when moving the tool point over them. The active reference will automatically switch to the one closest to the tool point. While doing this, and with a lot of references often close together, it can be difficult to avoid the references from switching if you want to navigate to a specific height or side reference or to a reference further away than other selected references. In this case, the user can lock a reference, isolating the navigation to this specific reference without deactivating all other active references.

You can select and lock a line, point, or surface that will be used as a reference.

If you are moving the tool point around on the project, the height and side reference will keep being locked to the selected reference, thus keeping this as the reference.

Locking a reference can be done in the reference menu or directly on the work screen:

- 1) Select an object by pressing the object name or directly on the visualized object on the run screen.
- 2) Press the **lock icon** to lock the selected reference.





3) Select 'Side', 'Height', or both:

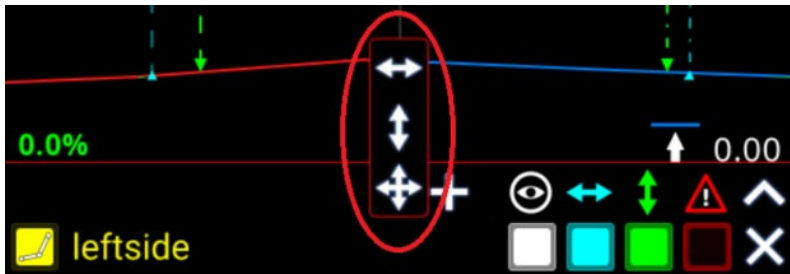

You can see that both 'Side' and 'Height' have a lock on them.

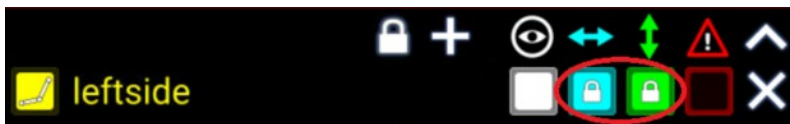

4) If you want to unlock it again, just tap once on the lock, and it will disappear.

5) If you want to lock the reference directly under your tool point, this can be done by pressing the lock icon next to the reference name on the work screen. This will toggle the lock icon between open and closed for either height or side reference.



#### 4.4.8. Dynamic 2D files

2D files, also known as background files or display models, are defined as files with no height information available. The height of all points in the file is set to 0.00 meters. These files are often used as background to visualize existing infrastructure or drainpipes where height was not logged originally. When working on projects with 2D files, they are not placed at a height of 0.00 meters. They are moved closer to the project, right below the active 3D references' lowest point. These files are handled dynamically, so whenever a 3D reference is activated or deactivated, the 2D files adjust accordingly.

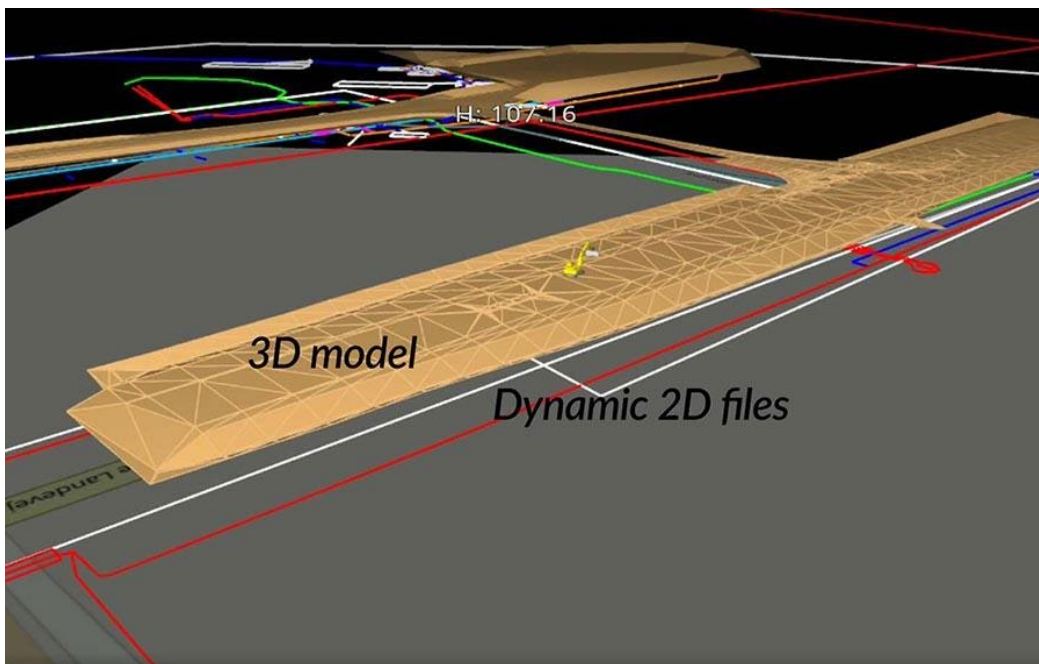

#### 4.4.9. Copy Point

You can now copy and edit a point by selecting one from the design model. However, it should be noted that you are not able to modify the points in the design model itself.

By using the edit feature, you can change the point's properties, such as its height. The edited point will be saved under your own points list (*user model*).

Additionally, you can utilize the Copy Point feature to duplicate any points from your personal point list.

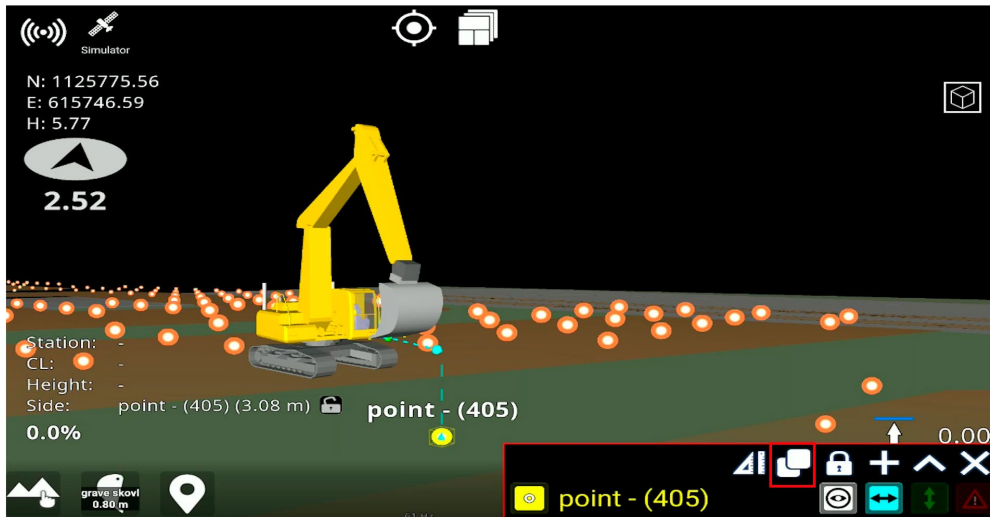

#### 4.4.10. Stakeout

Stakeout is showing the information for the selected line, point, or point on a line. To stake out an element, press the element in the graphics or press the element name in the reference dialog, and press the stakeout icon at the top of the reference dialog. A popup will appear with all the stakeout information for the selected element. The stakeout menu can be freely moved around on the tablet.

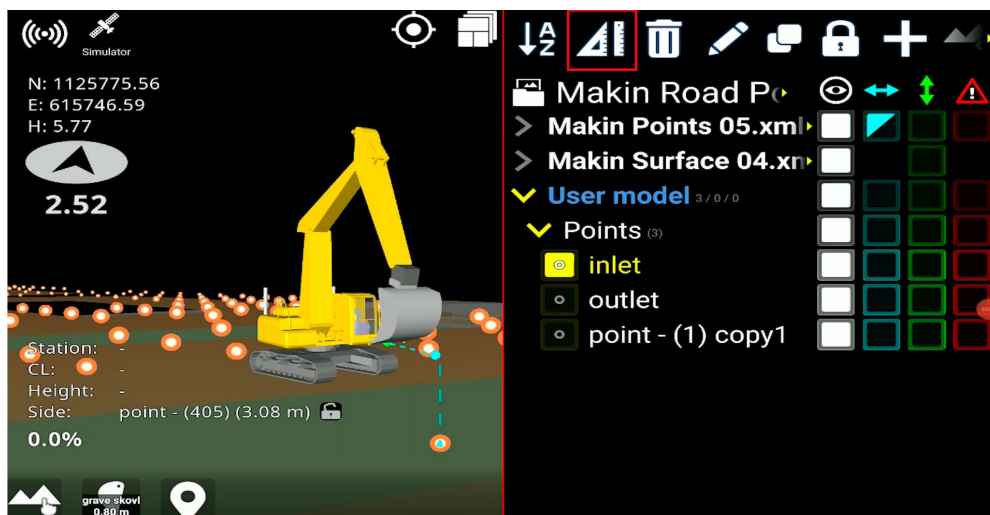

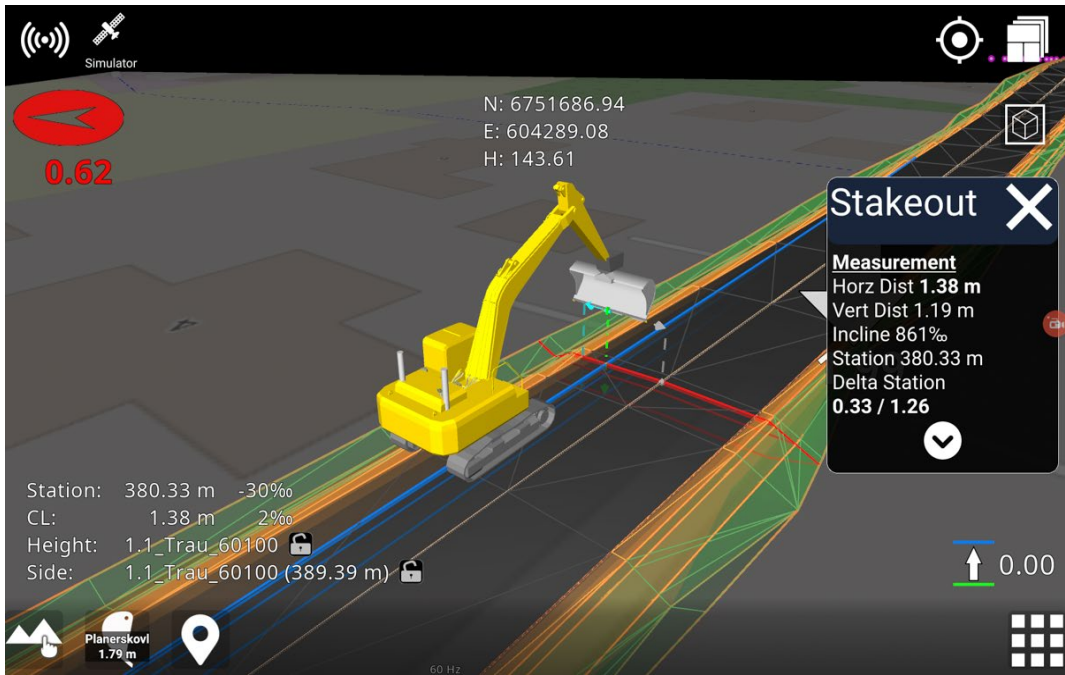

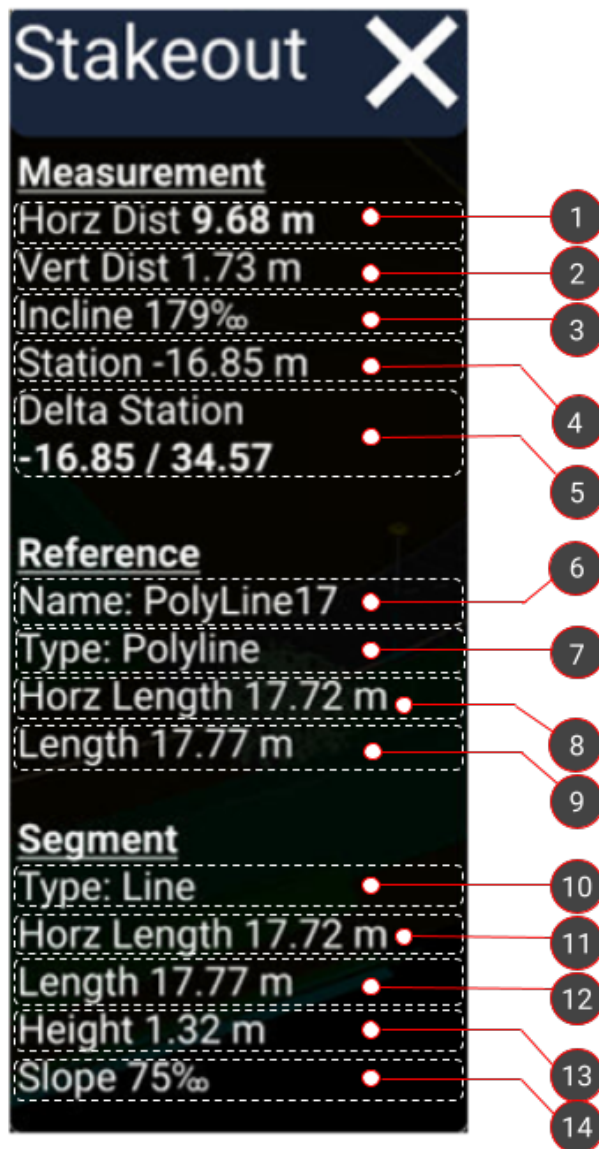

**Measurement:** Shows measurements between the tool point and the selected reference for the stakeout.

**Reference:** Shows information about the entire selected reference for stakeout.

**Segment:** Shows information about the active line segment (gray line). Only shown for lines that contain segments.

- |   |  |
|---|--|
| 1. Horizontal distance between tool point and selected reference. Measured perpendicular to the line. | 8. Horizontal length of stakeout line.                                     |
| 2. Vertical distance between tool point and selected reference.                                       | 9. Length of stakeout line.  |
| 3. Inclination between selected reference and tool point.   | 10. Segment type can be line, arc, or clothoid (spiral, transition curve). |

- |  |  |
|--|--|
| 4. Stationing of the selected line.  | 11. Horizontal length of line segment.     |
| 5. Horizontal distances from present stationing to the end points of the active line segment (colored gray). The line will be extrapolated, if the tool point is in front or behind end points. In this case, the value will be negative to the closest end point. | 12. Length of line segment.                |
| 6. Name of selected stakeout line.   | 13. Height difference of the line segment. |
| 7. Type of selected reference (arc, circle, line, polyline, road line)   | 14. Slope of the line segment.             |

#### 4.4.10.1. Stakeout to a point

When you want to stake out to a point, you can press the point or click on the name of the point in the reference dialog, and then press the stakeout icon .

A bullseye and a popup with the stakeout information will appear on the screen. The blue line in the bullseye indicates the long slope direction, and the red line indicates the cross-slope direction.

The popup with the stakeout information will show information about measurement and reference.

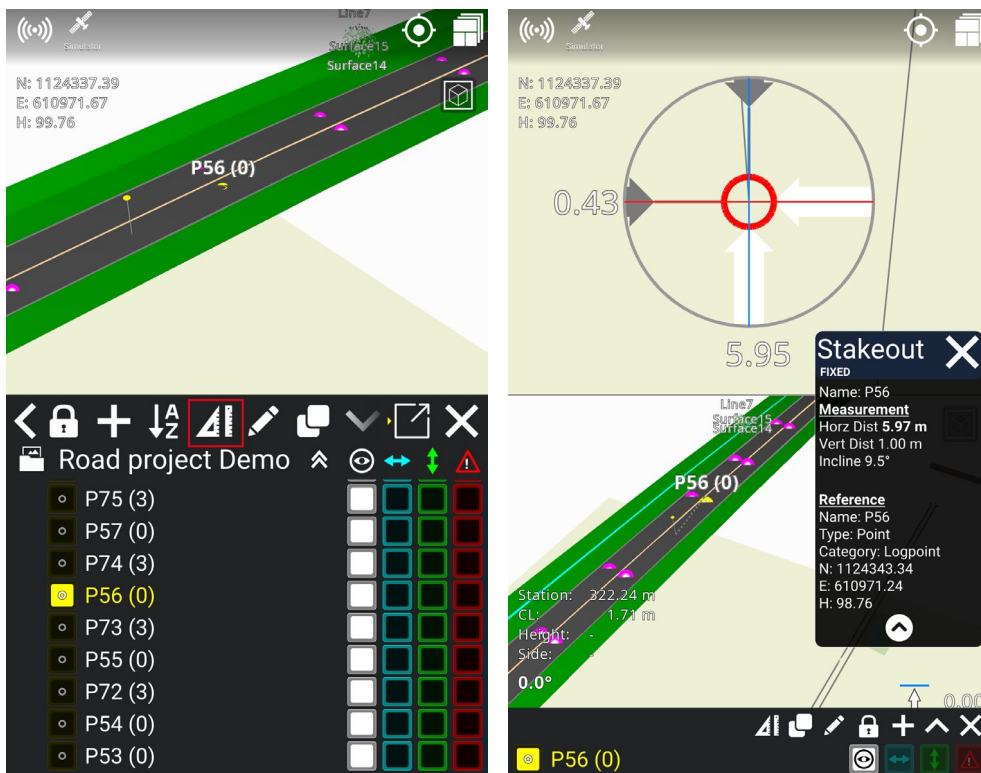

#### 4.4.10.2. Stakeout to a line



When you want to stake out to a line, you can press the line on the screen or click on the name of the line in the reference dialog, and then press the stakeout icon .

A dotted line from the application to the selected line will show on the screen, along with a popup with stakeout information. The stakeout information will show information about measurement, reference, and segment.

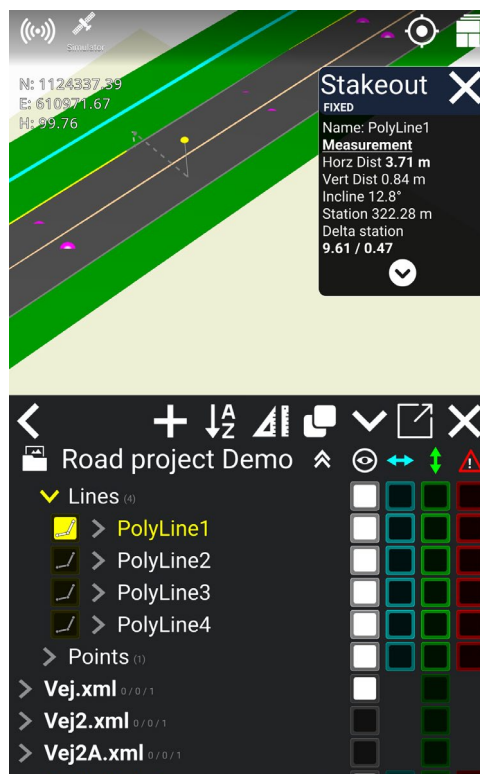
If you move beyond the line, the dotted line will show the extrapolation of the selected line. Please note that if you stake out to a side reference, the line does not extrapolate.



#### 4.4.10.3. Stakeout to a line point

If you want to stake out to a point on a line, you must press the arrow between the line symbol  and the name of the line in the reference dialog. Then the name of the line point will appear underneath the arrow. Select the line point you want to stakeout to, and then press the stakeout icon .



A bullseye and a popup with stakeout information will appear on the screen. Like stakeout to a point, the blue line in the bullseye indicates the long slope direction, and the red line indicates the cross-slope direction.

The popup with stakeout information contains information about measurements and references.

#### 4.4.10.4. Stakeout to side reference

You can stake out to side references, which allows you to see multiple elements' information by jumping between them when you use the stakeout feature.

##### How to use:

- 1) Activate the elements you want to use as a side reference by pressing the boxes underneath the blue horizontal arrow in the reference dialog. When you activate a box with a blue edge it will change to a fully blue box.

- 2) Press the stakeout icon .



- The application will now stake out to the nearest element, and when you move around, the application will switch to stake out to a new nearest element. A popup with stakeout information will also appear on the screen.

The popup with stakeout information will show information about the name of the element, so you know which element the application stakes out to. The popup also contains information about measurements and references.

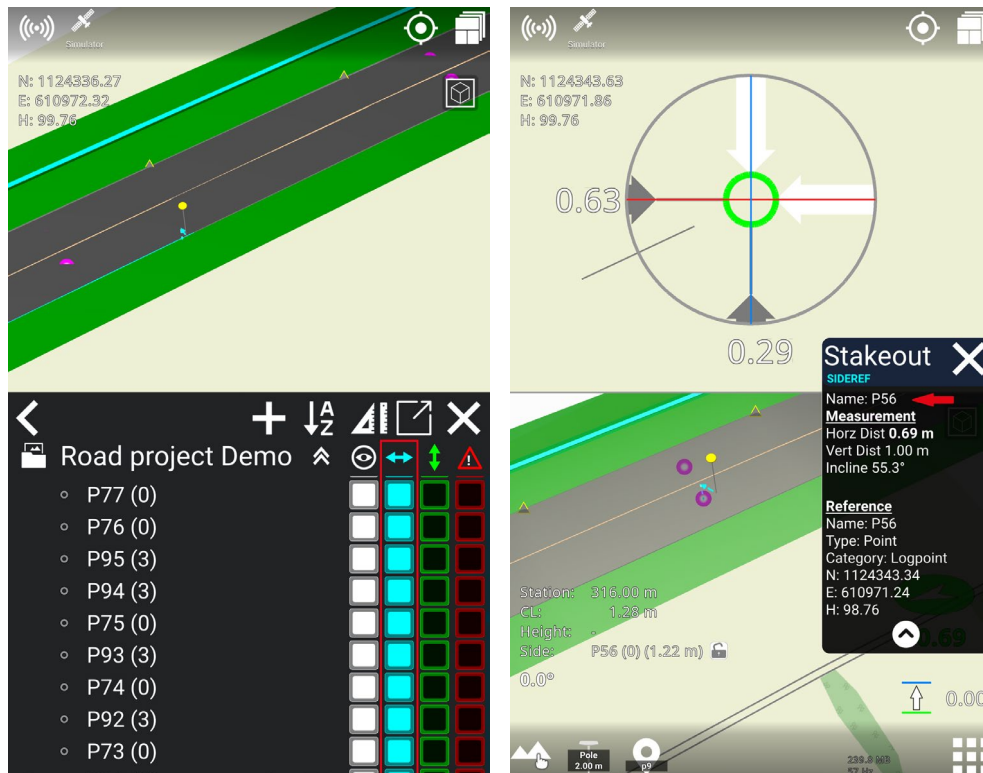

#### 4.4.11. Create point from coordinate

- Press on **References**:

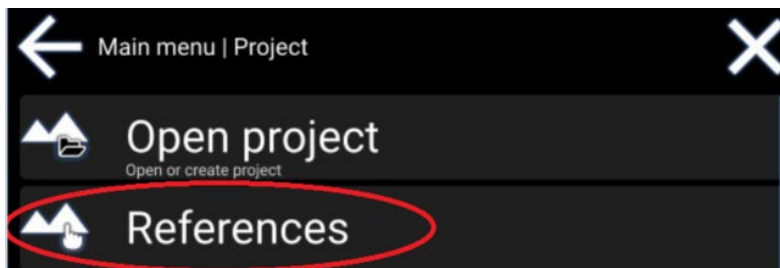

2) Press the '+':

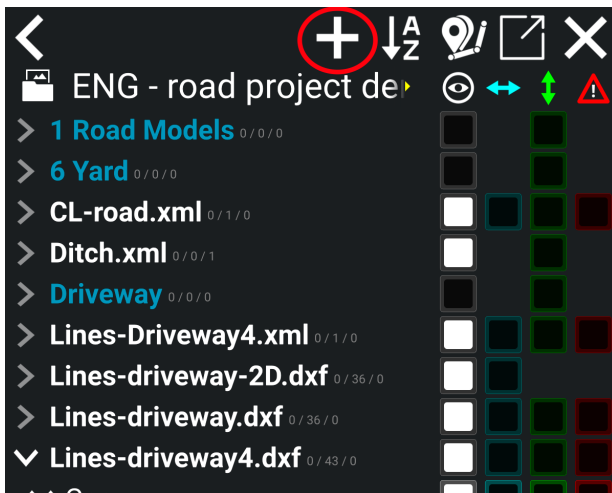

3) Press the **point** icon:

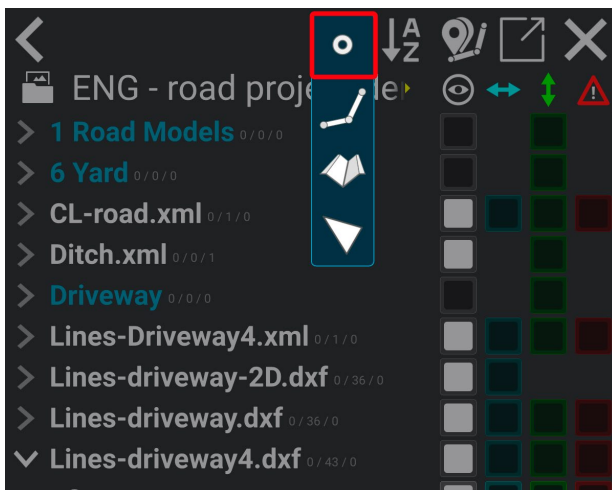

The point will have the coordinates of the bucket's selected measurement point.

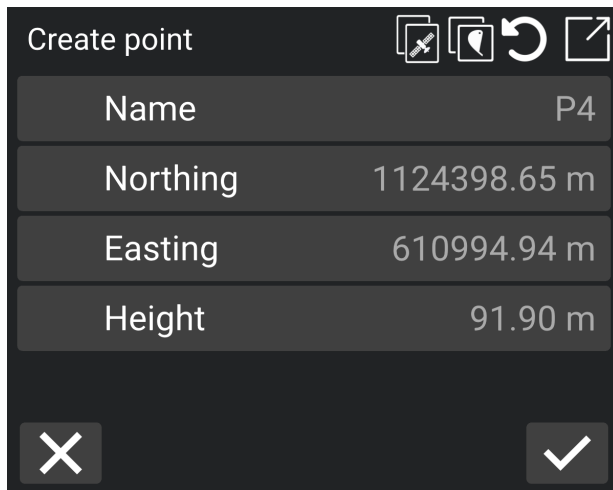

- 4) Set a name for the point.
- 5) The point's coordinates can be adjusted manually.
- 6) It is also possible to adjust the bucket's position and fetch the new position of the bucket (see the bucket icon in the picture above).
- 7) Tap the check mark to confirm the new point.

Points you have created yourself can be found at the bottom of the **'References'** under **'User model'** > **'Points'**.

#### 4.4.12. Create line from points

- 1) From **'References'** tap **'+'** and then **'Line'**.

You can create lines between existing points - either from a design model or from points you have created yourself.

The line will be created in the order in which points are selected, and you will see how the line appears in the on-screen overview.

- 2) You will be prompted to **'Select the points for the line'**.
- 3) Select the points individually by either picking points in the 3D visualization or highlighting the yellow icon next to them in the list.

- 4) Finish by pressing **'OK'**.
- 5) Give the new line a name.
- 6) If you have selected three points or more, you can select the **'Close line segment'** option to connect a line between the first and last points.
- 7) Finish the line by pressing **'OK'**.

### 4.4.13. Create profile along lines

- 1) From **'References'** tap **'+'** and then **'Profile'**  .

The line will function as the centerline for the profile, where you can add any number of surfaces on either side of the line.

- 2) You will be prompted to **"Select the lines for the profile"**.
- 3) Select the lines for the profile in the 3D visualization or in the list. When done, tap **'OK'**.
- 4) Give the profile a name.
- 5) Press the **'+'** button on the left and right side of the screen to respectively add new surfaces on the left or right side of the line.
- 6) Adjust each of the surfaces' width, Deltaheight dH, and angle according to the design that you want.
- 7) You can also adjust the height offset of the entire profile.

#### 4.4.13.1 Edit profile

**Main menu > Project > References**

You have the possibility of editing an existing profile. In this way, you can edit the profile's width and slope of the surfaces, as well as add or remove surfaces.

- 1) Under **User model**; longhold on the profile surface name, which you want to edit.
- 2) Click on the **pen tool**, which will appear.

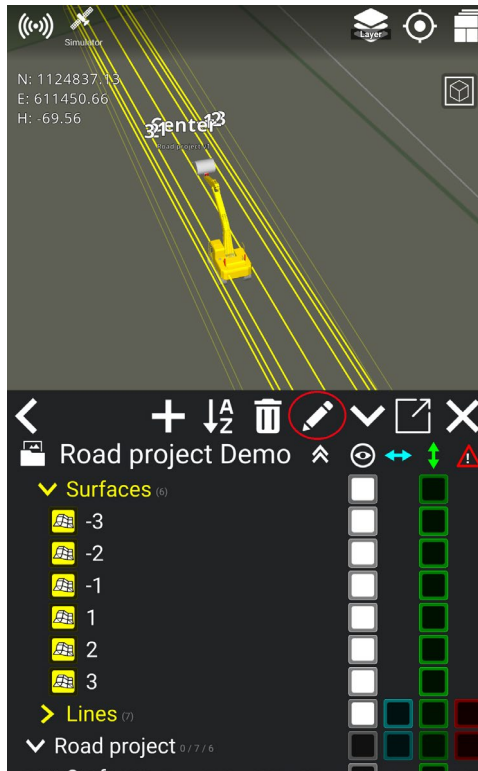

- 3) Adjust the width, the deltaheight dH, and/or the angle of the surfaces by clicking on the numbers you want to change.

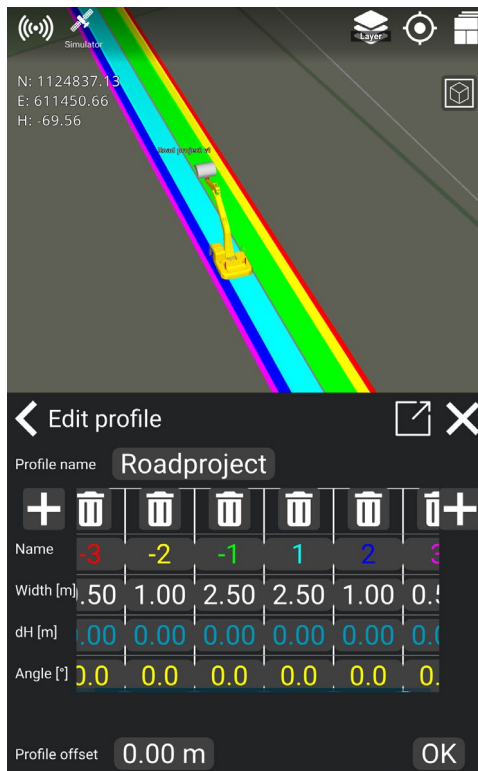

- 4) The profile will now change according to the new width and slope of the surfaces.

#### 4.4.14. Create surface

To make a surface, you start by connecting three points to form a triangle. These points determine the shape and size of the surface. You can create more triangles from the points to expand the surface.

- 1) Go to **Project > References**.
- 2) Tap on the '+' symbol.

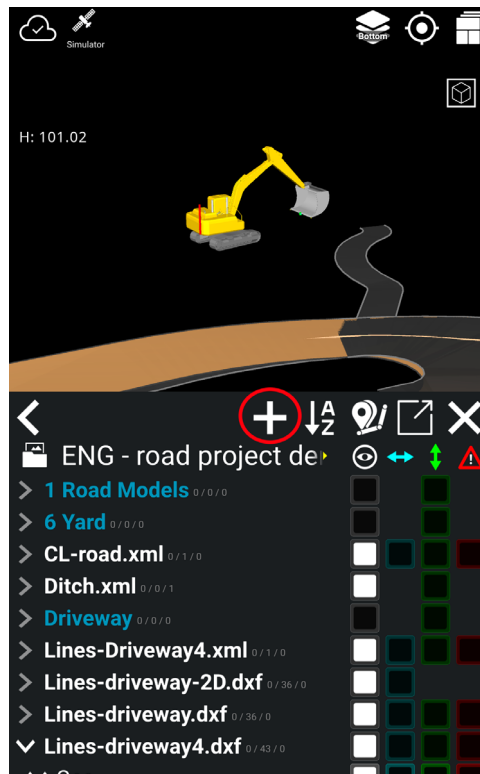

- 3) Tap on the triangle icon.

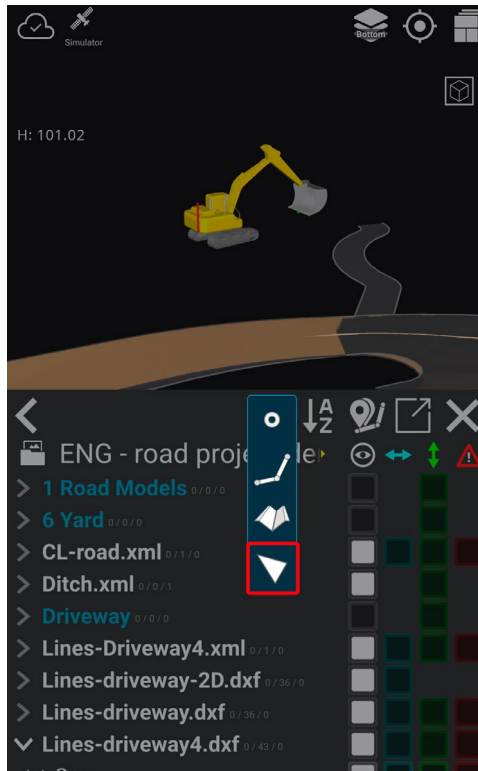

- 4) You can select three points for the triangle or add the points by pressing the **add point button**.

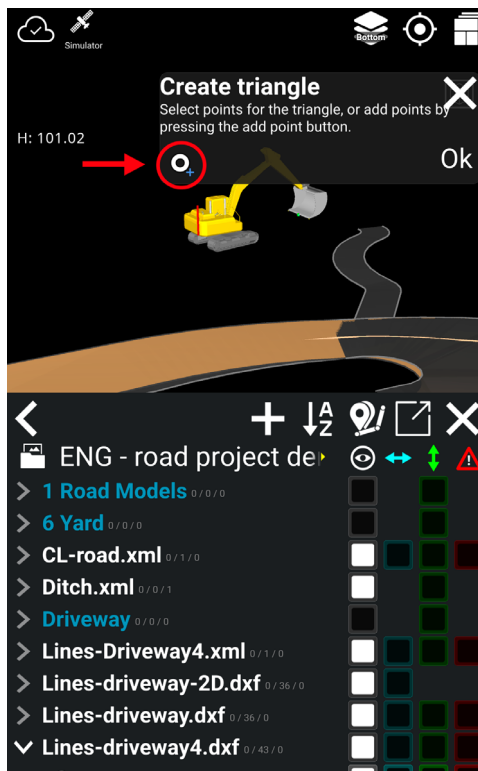

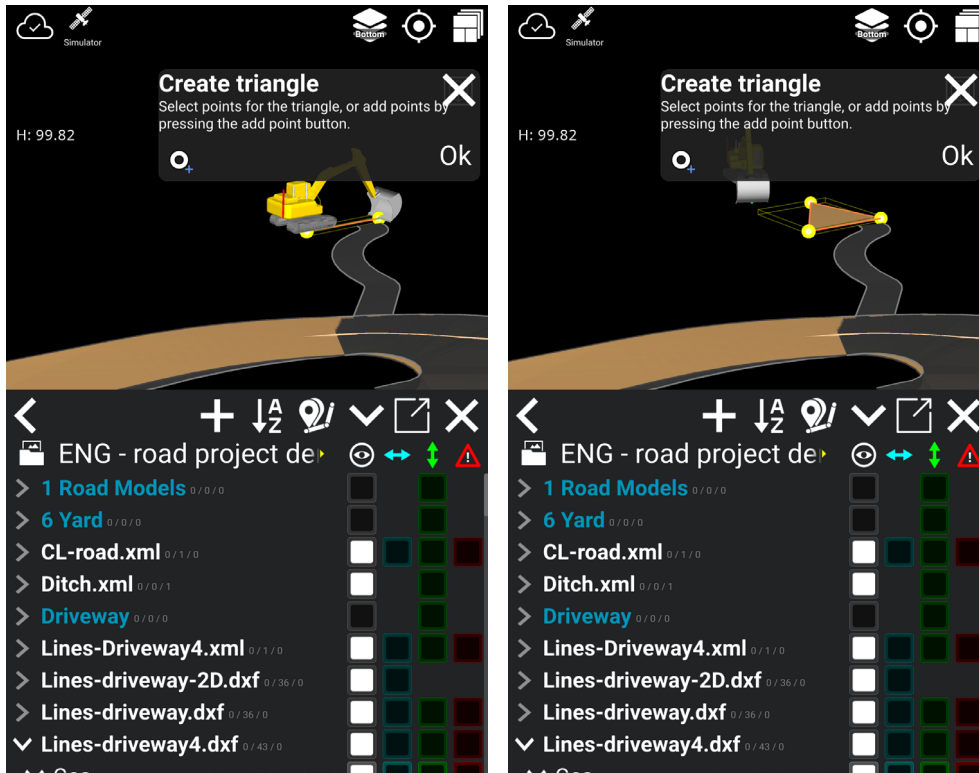

5) When the three points are added/selected tap on 'Ok'.

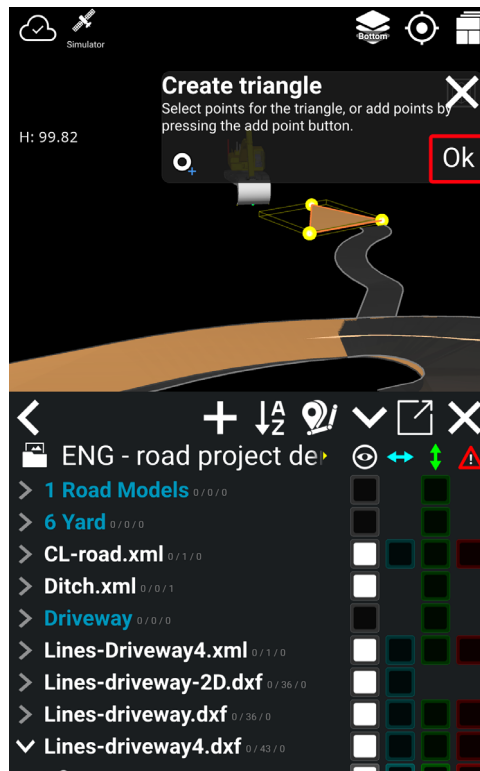



6) Name the surface by tapping on 'Name'.

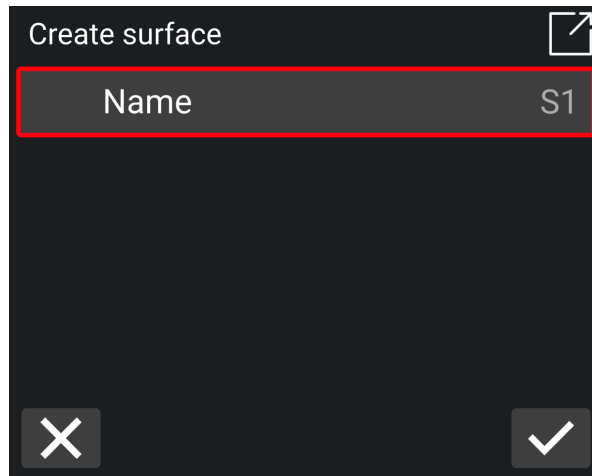

7) Name the surface.

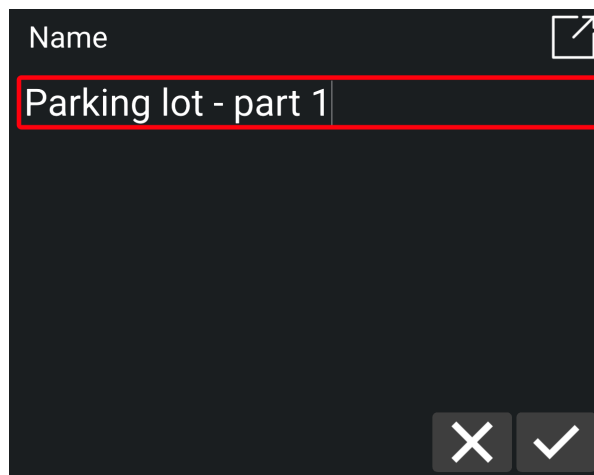

8) Tap on the check mark to save.

9) Tap on the check mark to complete surface creation.

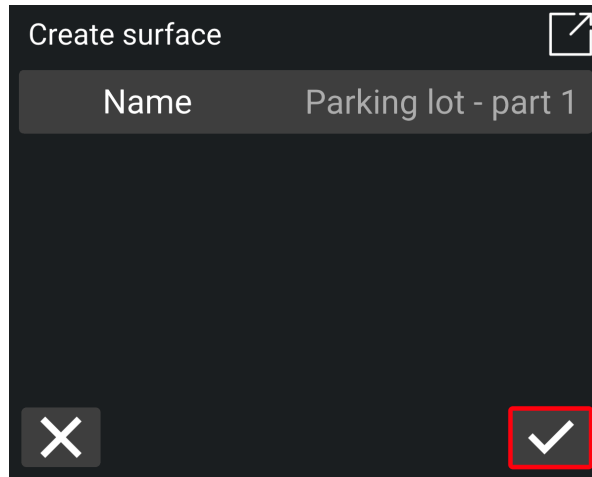

10) You can expand the surface by creating a new triangle by selecting two points from the existing triangle and adding a new point.

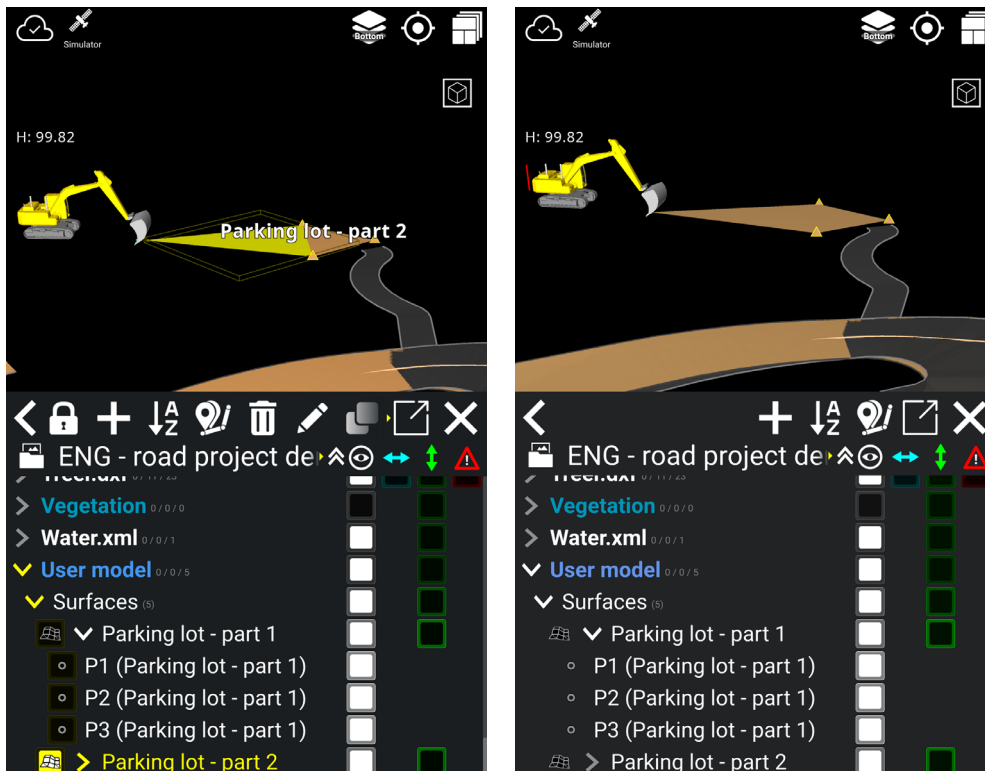

## 4.4.15. Edit Line

You can edit line points in the user model if you need to change the coordinates/location of an existing line. Be aware that you can only edit your own lines located under the user model, meaning that you cannot edit lines from project- or As-built data.

- 1) Go to **References > User model > Lines**.
- 2) Click on **'Lines'**.
- 3) Choose the line you want to edit by clicking on the line or the arrow in front of the name of the line. For example:

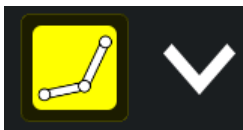

- 4) Click on the point of the line you would like to change, for example:

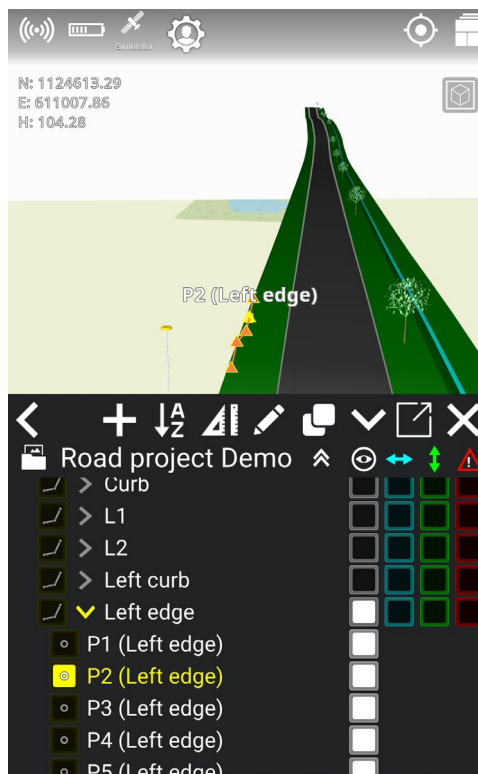

- 5) Click on the **pen tool** to edit the line point.

- 6) Change the desired coordinates of the point's position. The line will now change in relation to the point's new position.

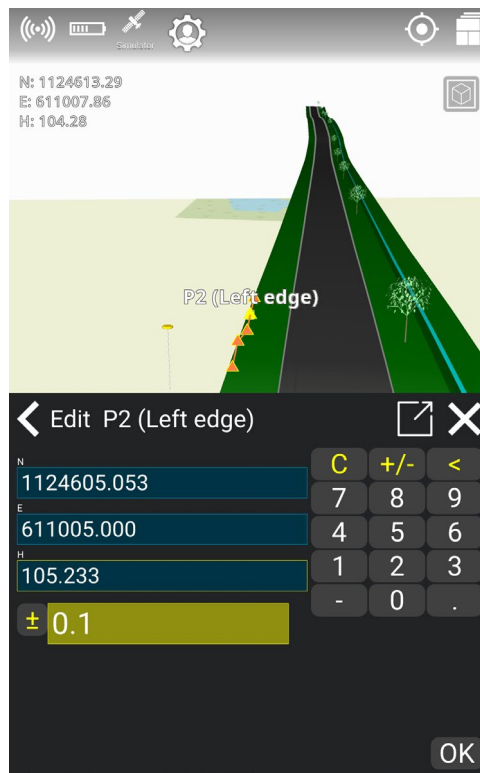

#### 4.4.15.1. Copy a line from design data in order to edit it

Because you cannot edit lines from design data, you can instead copy a line from the design and edit the copied line points in the **User model**. In this way, you can still follow the line and make adjustments to the line points, e.g., if you want to change the height of a line point.

##### How to copy a line:

- 1) Select the line you want to copy from the design.
- 2) Click on the 'Copy' icon:



- 3) You can rename the copied line. Press '**Ok**' to copy the line.
- 4) The copy is now under '**User model**', where you can edit the line.

## 4.5. Fix point control

Menu > Project > Fixpoint control

If a construction site has set up fix points, then the points will not be visible for the machine operator in the Makin' 3D app. To find the fix point control, go to **Project > Fixpoint control**.

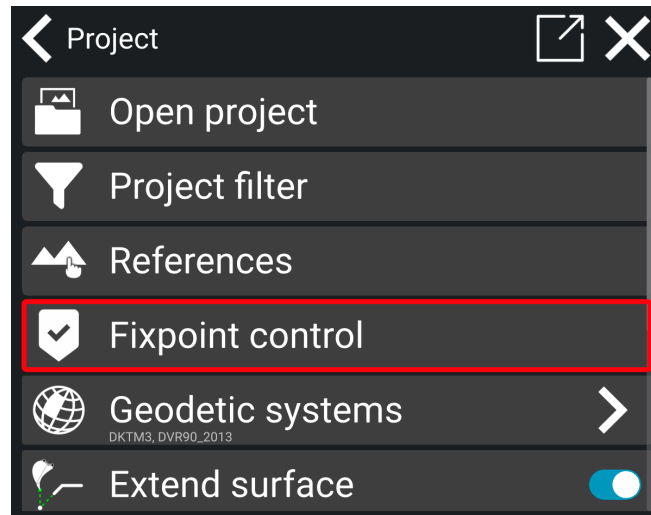

If there are no fixed points in the project a warning will pop up.

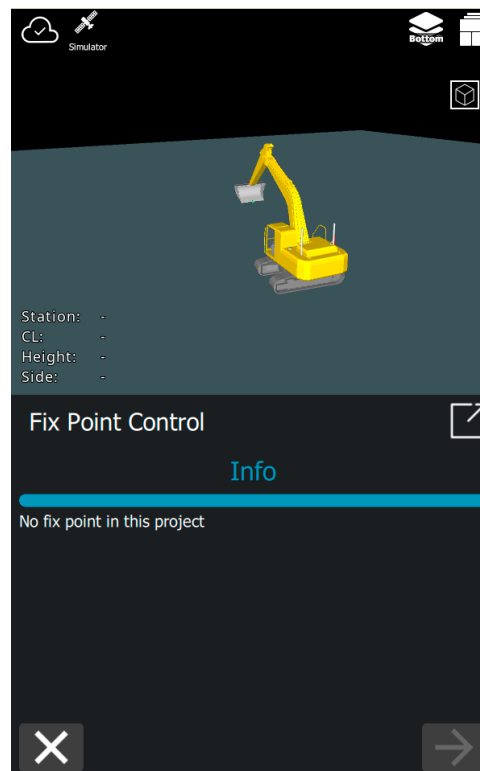

## How to do a fix point control:

- 1) Mark the tool point by tapping on the bucket.

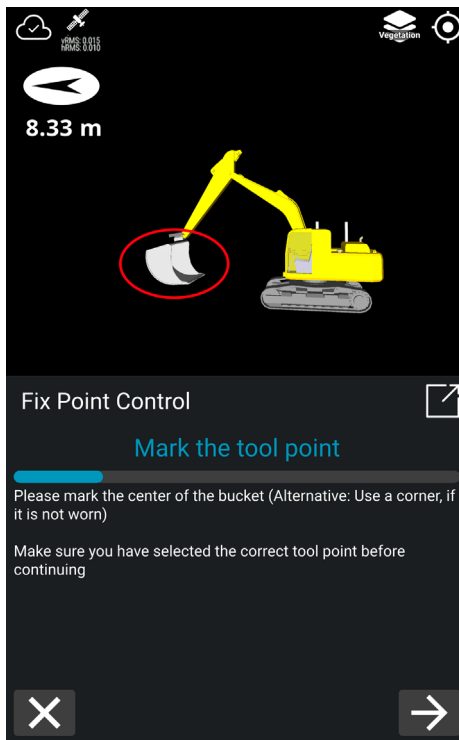

- 2) Choose the correct tool point.

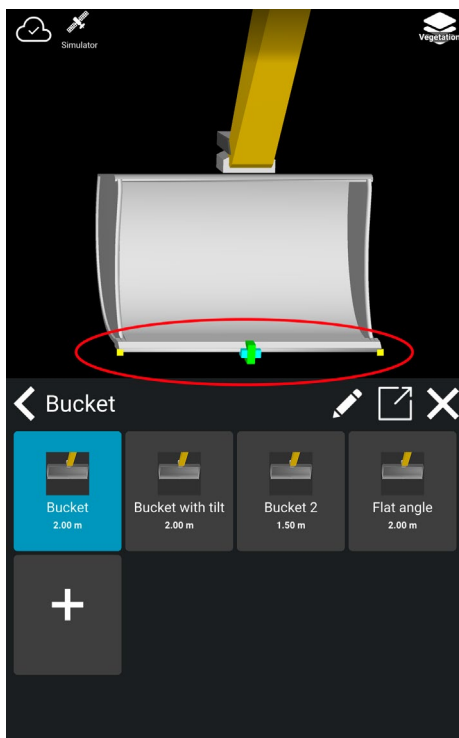

3) Go back to the **fix point control** by tapping on the arrow.

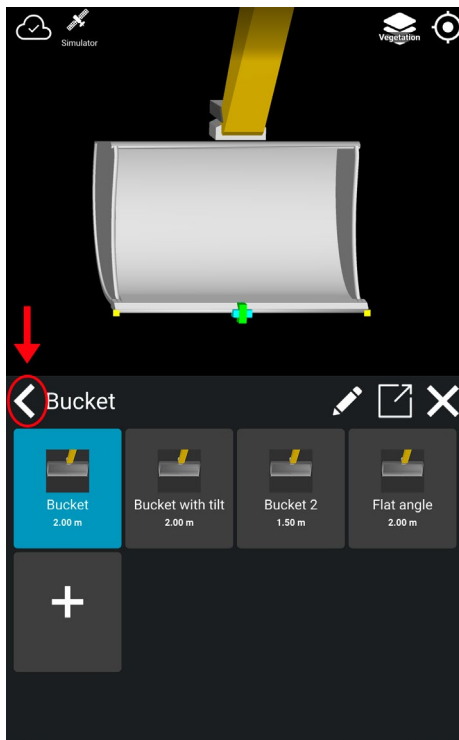

4) Go to the next step by tapping on the arrow in the bottom right corner.

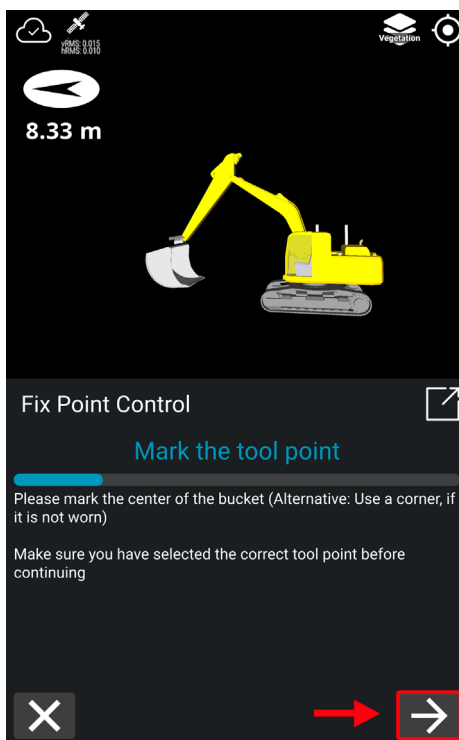

- 5) Locate the fix point. Navigate the machine to the nearest fix point by following the side distance in the top left corner.



- 6) Open the bucket and place it on the fix point. Follow the picture on the screen by placing the open bucket with the tool point on the fix point.
- 7) Tap '**Measure**'.



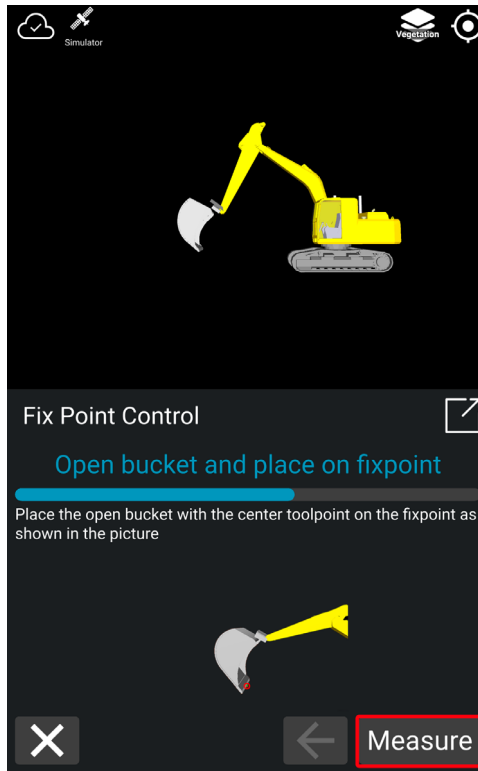

8) Close the bucket and place it on the fixed point. Follow the picture on the screen by closing the bucket and placing it again with the center tool point on the fix point.

9) Tap **'Measure'**.

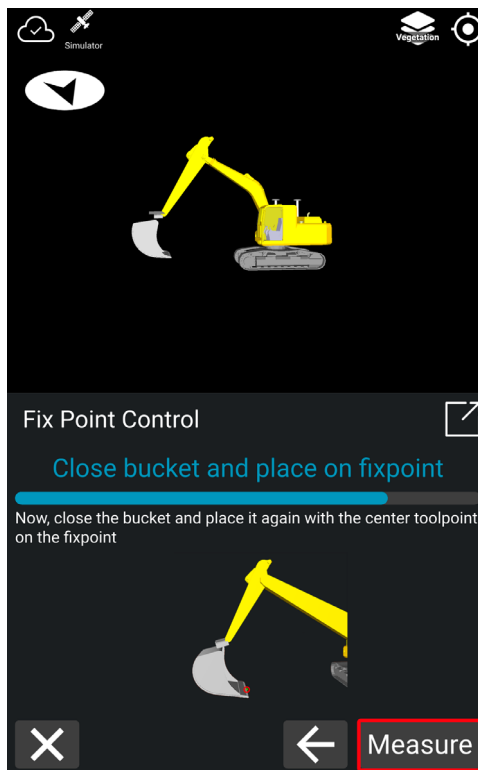

10) The report for the fix point control is displayed on the screen. It shows the difference horizontal and vertical for both the open and closed bucket.

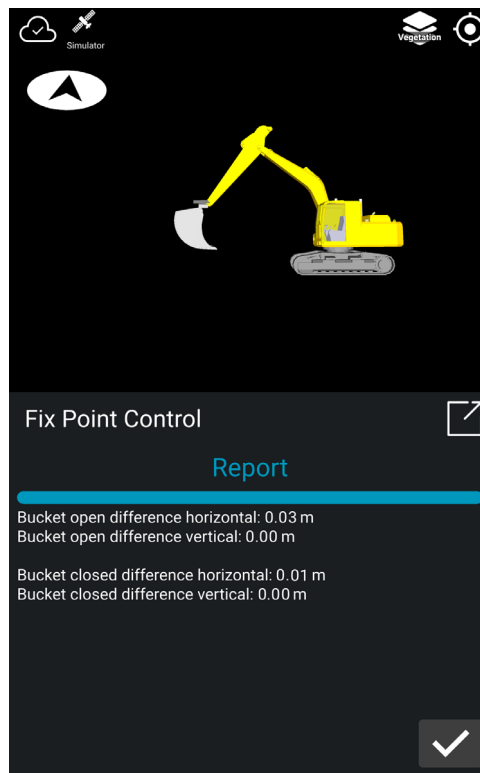

11) Tap on the check mark.

## 4.6. Geodetic systems

### Menu > Project > Geodetic system

Only in rare cases should the machine operator be concerned about selecting the correct coordinate system and geodetic model. With Makin' 3D these matters are handled in a central place - e.g., the construction office. When made available, the geodetic system cannot be changed on the excavator. It is possible though, to handle the geodetic system locally when required by simply not having it preselected for a particular project.

## 4.7. Extend surface

Menu > Project > Extend surface

Extending the surface allows you to continue your excavation even if you are beyond the design that is already at hand. By selecting '**Extend surface**', you extend the road surface you are working on - even if the actual design has limitations. The same is true for cuts where the cutting surface is too short for you to find the cutting top.

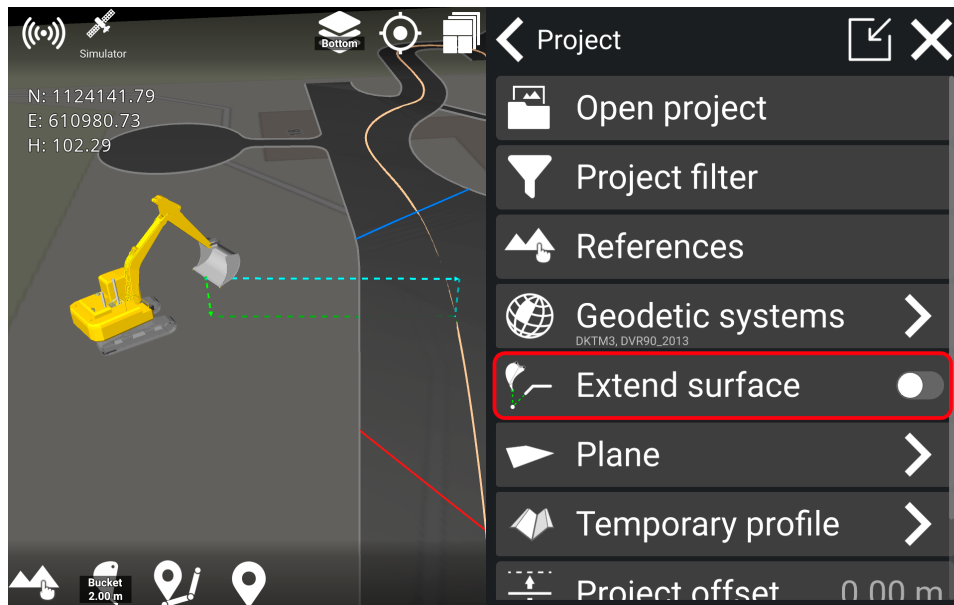

The way the surface extends depends on the file format you are using:

**Road formats:** For road formats like road lines and xml. files, the surface will extend perpendicular to the centerline when you select 'Extend surface'.

**Other formats:** For surfaces with other formats like dxf. and landxml. the surfaces will extend with a heading cut across, when using the feature 'Extend surface'. It means that the extended line will move along with the bucket's cutting edge.

*Note that when you extend the surface, only the current tool point's height will be shown when you are beyond the design. Only one height will be calculated, which will be the height from the active tool point.*

### Extend surface using road formats:

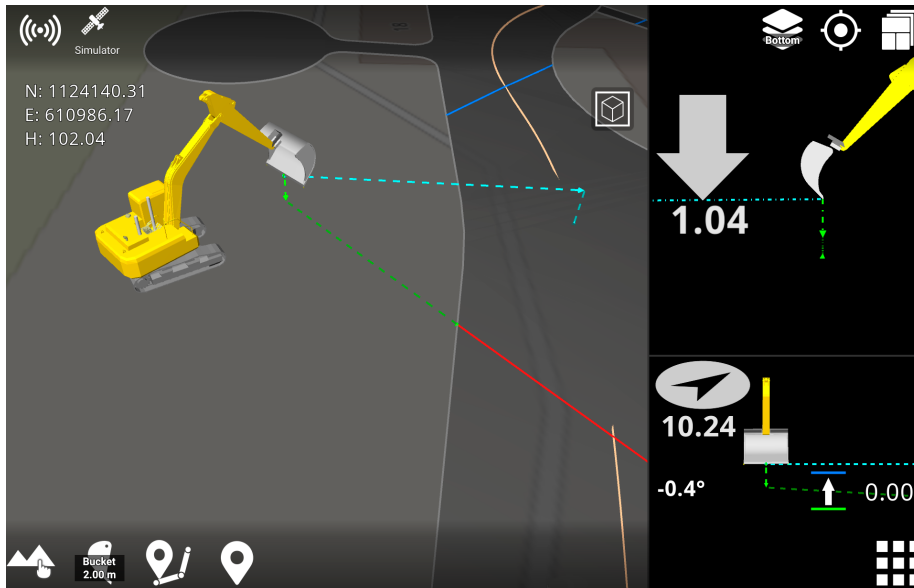

### Extend surface using other formats:

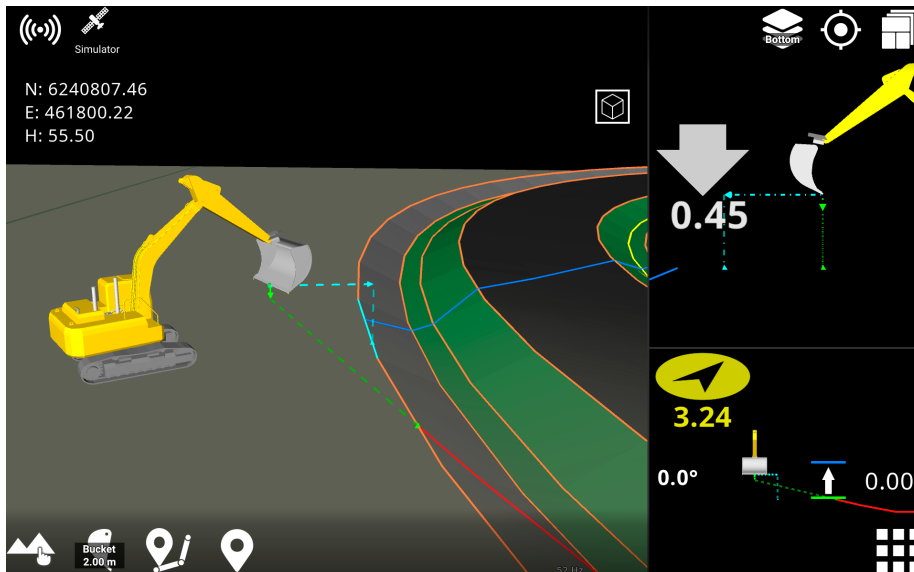

## 4.8. Plane

Menu > Project > Plane

By activating the **'Plane'** feature, you get a virtual reference plane, which can be either flat or sloping with a 1-sided or 2-sided fall.

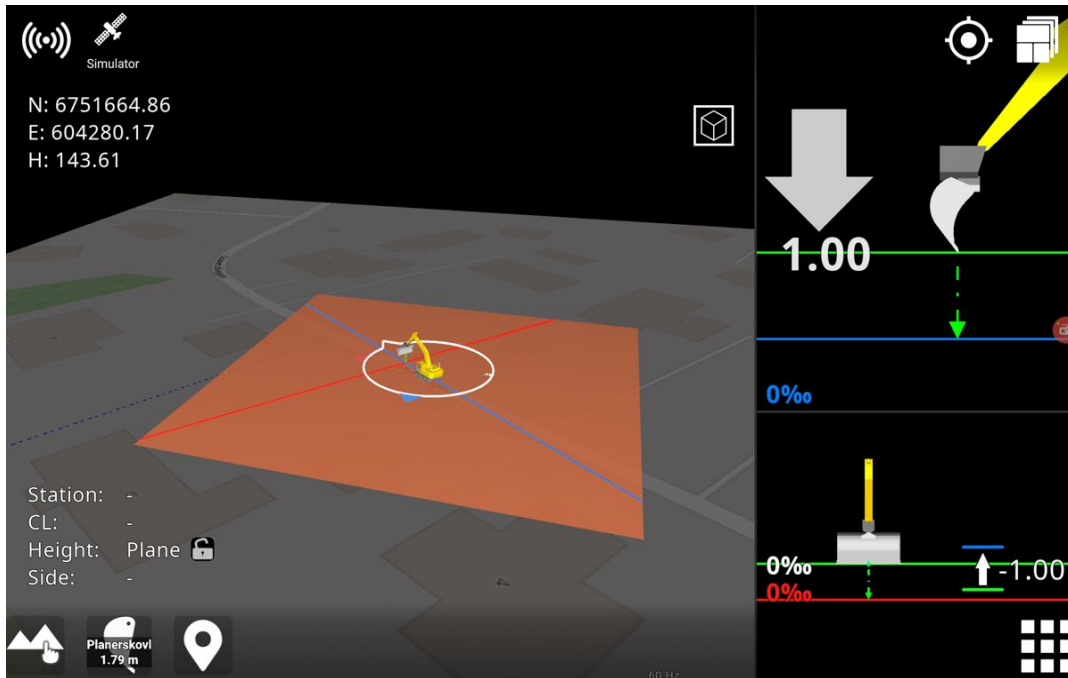

Use **'Main direction'** and **'Main slope'** to indicate the plane's longitudinal direction and angle. Likewise, set the transverse slope of the plane with **'Side slope'**.

With the **'Elevation'** option, specify the absolute elevation height or quickly get the current height of the tool point. Another option, called **'Set plane here'**, also uses the current tool point height, but with the addition of taking the reference height offset into account.

When the plane is active, you can tap the visual part of the plane to quickly change its values. When you no longer need this feature, it is important to disable the plane. If you do not do this, the activated plane will follow the machine wherever it may be located.

Tap to activate and deactivate a virtual plane and change the longitudinal direction, longitudinal slope, and transverse slope.

If you set the height manually and then enter a longitudinal fall, the point for starting the slope will still be below the "cross thread", which forms the center of the measuring point on the bucket. Those are the E and N coordinates that you can see in the upper left corner. It is important to keep in mind that the measuring point on the bucket is above the desired starting point for length/cross slope.

## 4.9. Temporary profile

Menu > Project > Temporary profile

Toggling the **'Profile'** option turns the temporary profile on or off while its settings are retained.

There are two options for moving the profile, respectively **'Set profile here'** and **'Set profile & direction here'**. The first option horizontally displaces the profile and positions the middle of its centerline at the tool point. In addition, the latter option also rotates the profile according to the heading of the bucket/attachment.

Adjusting the **'Slope'** will tilt the profile along its baseline.

Under **'Edit profile'** you can change the profile's contours by adding and removing surfaces as well as changing the width and slope of the surfaces. Changing slopes can be done either by specifying the height difference between two surfaces or by specifying the percentage slope between them. Also, you can specify a height offset for the profile, where the baseline is indicated by a gray line in the 3D view.



The profile can be rotated by using **'Edit direction'**. North corresponding to 0 (zero) degrees. The feature **'Get direction from tool'** will align the profile according to the bucket/attachment.

As an alternative to going via the menu, you can jump to this feature by tapping the profile in the 3D view.

## 4.10. Project offset

Project offset is designed to adjust a machine's height to match the height of the design project you are working on. Even if a machine is correctly calibrated, the height measured by the tool point in the application can differ from the height of a known point on the project. These differences can occur as a result of differing reference systems, e.g.: localized coordinate projections vs. official coordinate projections. Other sources include small variations between GNSS manufacturers as well as incorrect heights used in the initial project design.

To mitigate this, we have added the project offset functionality, which adjusts the received GNSS height (not the antenna height) to match the height of the known point on the project.

### Note:

You must ensure that the machine is calibrated correctly before adjusting the project offset. Project offset is limited to adjustments of +/- 50 cm.

Project offset can be adjusted in: **Main Menu > Project > Project offset**

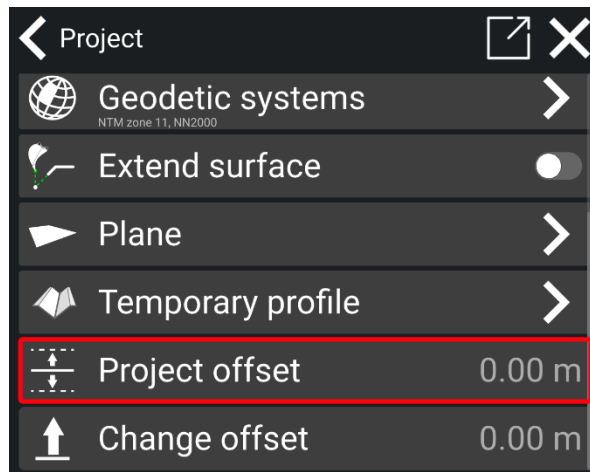

### How to use:

- 1) Inside the project offset menu, you will see the tool point height of your application in the value area.

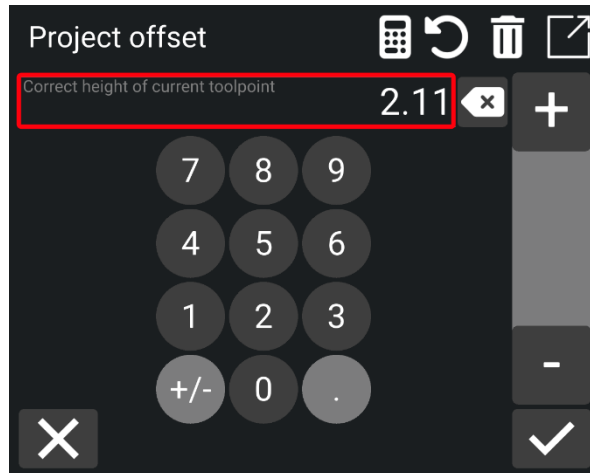

- 2) Enter the correct height of the known point in the value area to calculate a project offset.
- 3) It is also possible to adjust the project offset using the +/- buttons, increasing or decreasing the value by 1 cm per tap.
- 4) A project offset is calculated and visible in the project menu. When you have a project offset, the icon will be visible on the work screen.



To remove the project offset, go into the **Project Offset menu** and tap the **trash can icon**.



## 4.11. Change offset

Menu > Project > Change offset

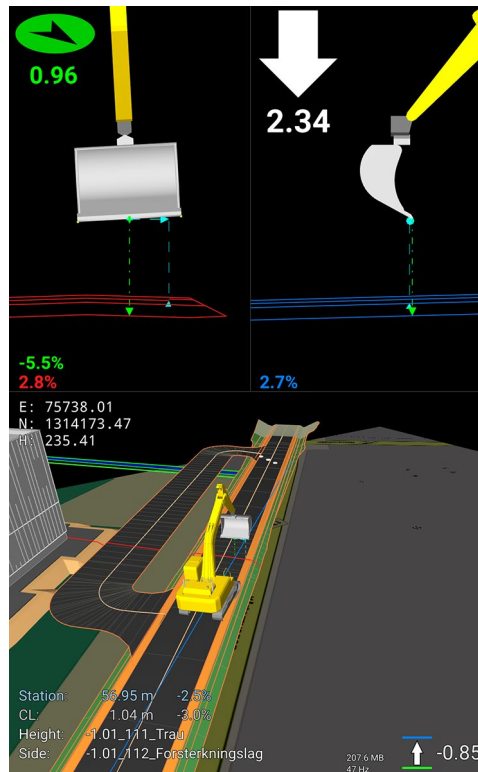

Entering this menu adjusts the height offset you want to have for the whole project. Typical uses are where you have only been given the surface of a road and should dig for a ditch or other layers beneath the surface. If the ditch is known to be 0.85 meters under the finished road, then adjust the offset value to -0.85. A parallel surface/line will then be created 0.85 meters beneath the theoretical model. The whole model will be offset.

You can enter the desired value manually or move your finger up or down in the vertical field.

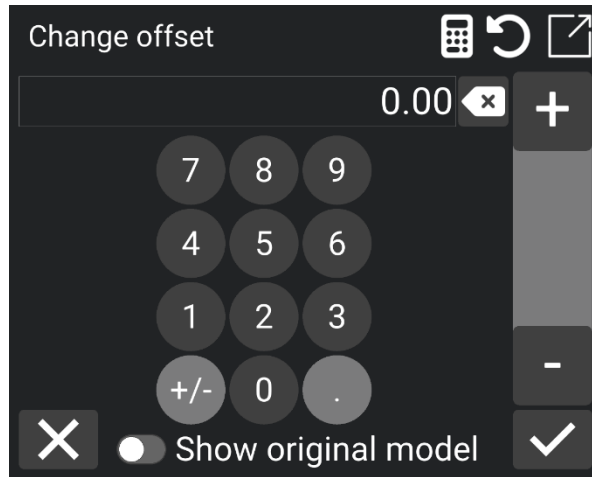

If you have applied an offset but want to view the model with its original offset, enable '**Show Original Model**'.

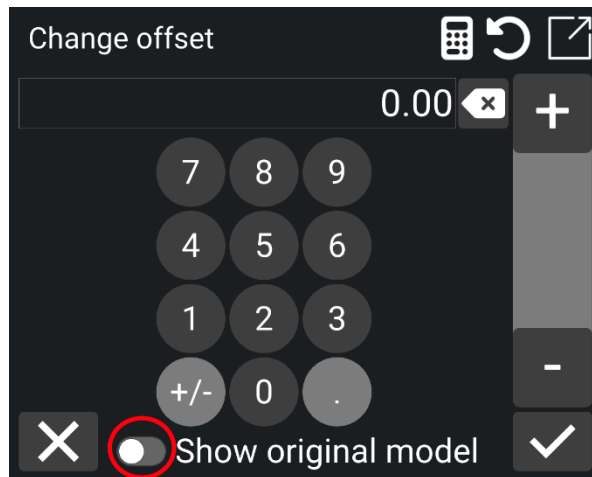

# 5. Display

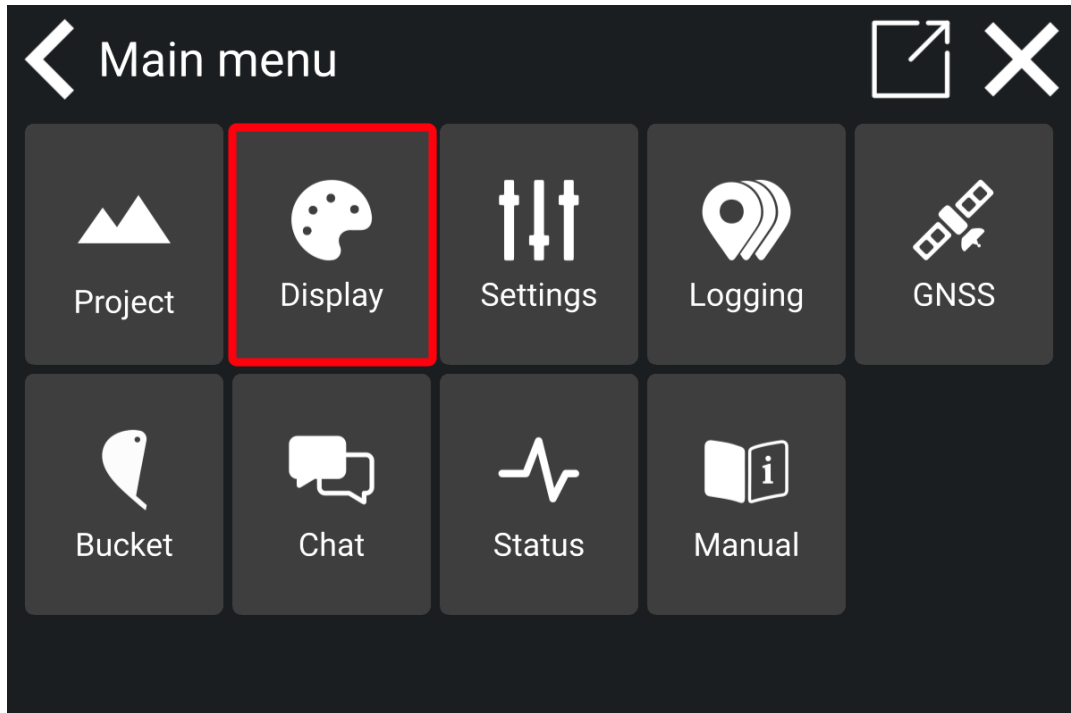

## 5.1. Labels

**Menu > Display > Labels**

A label is the name of a geometry object of the following type:

- Points
- Lines
- Surfaces
- Stations
- Log Points
- Log Objects
- Texts

It is possible to choose which type of label should be visible by selecting/deselecting it on the list.

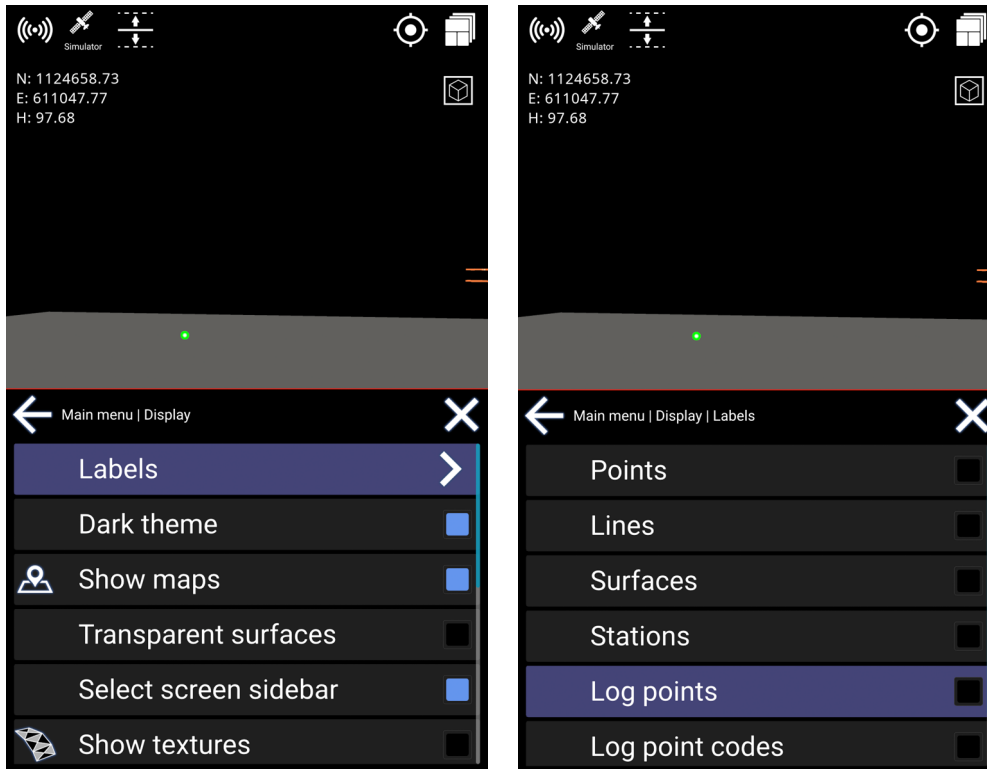

## 5.2. Use file color

### Menu > Display > Use file color

This feature changes between using the colors stored on file or the default color scheme of Makin' 3D. In some situations, it gives a better overview using the colors of the model file and will make it easier to separate elements in a complex file.

If file color is not enabled, Makin' 3D will use default colors.

Be aware that some files can include black-colored lines or designs, and these will not be visible if file color is selected.

Tap to select/deselect file colors

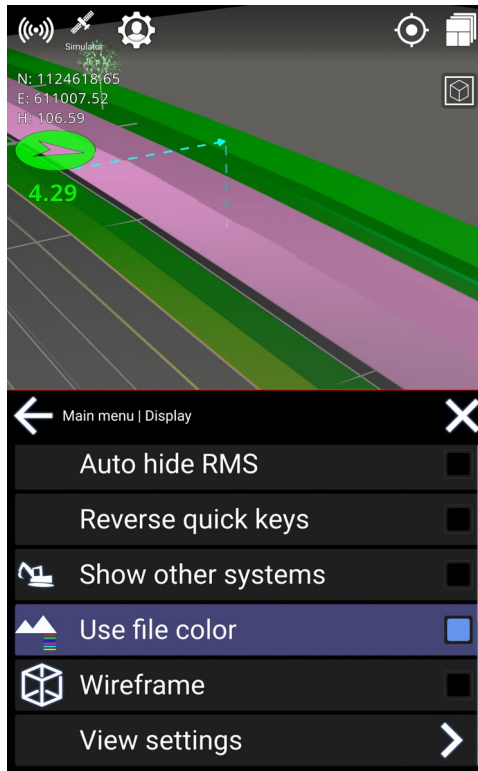

## 5.3. Show maps

**Menu > Display > Show maps**

The user can hide or show maps along with the project to get a better overview. The map will be shown below the lowest active 3D reference in the project.

The tool cuts are shown on the map in Top View. Otherwise, tool cuts are only shown on elements of the 3D model marked as a height reference.

Note: In the 3D View, the map will be seen in a perspective view. If you want to see it straight from above, use the Top View instead.

- Tap to select/deselect visibility of map

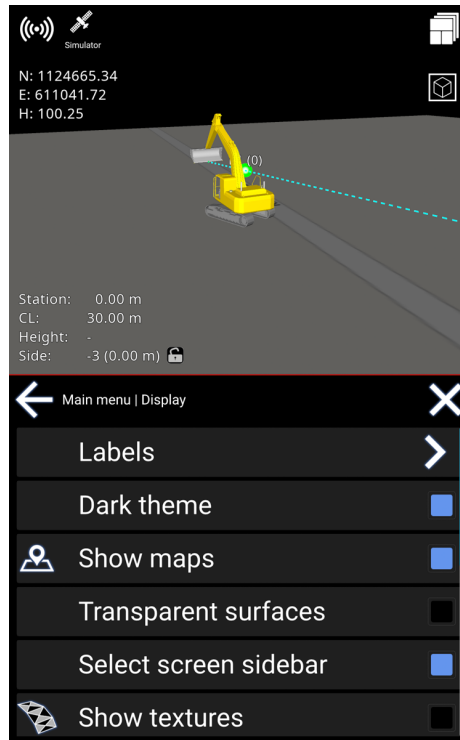
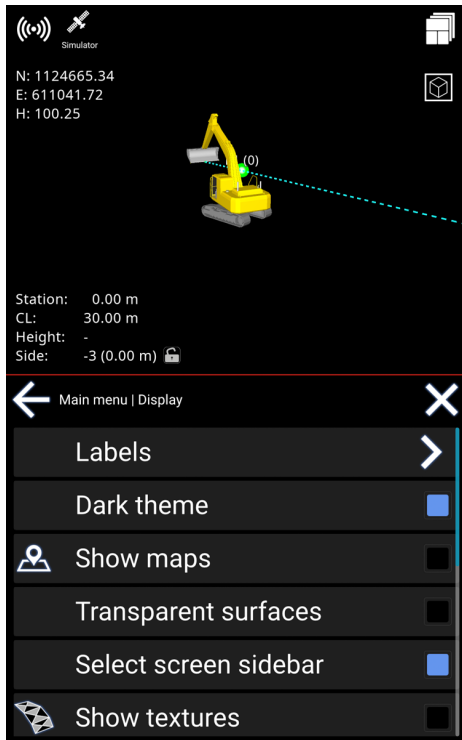

## 5.4. Show other systems

Menu > Display > Show other systems

Other systems currently working on the same project - like machines, rovers, etc. - will show up.

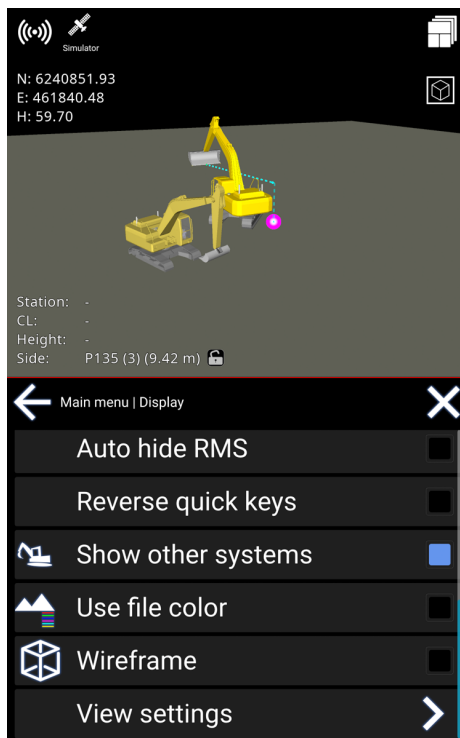
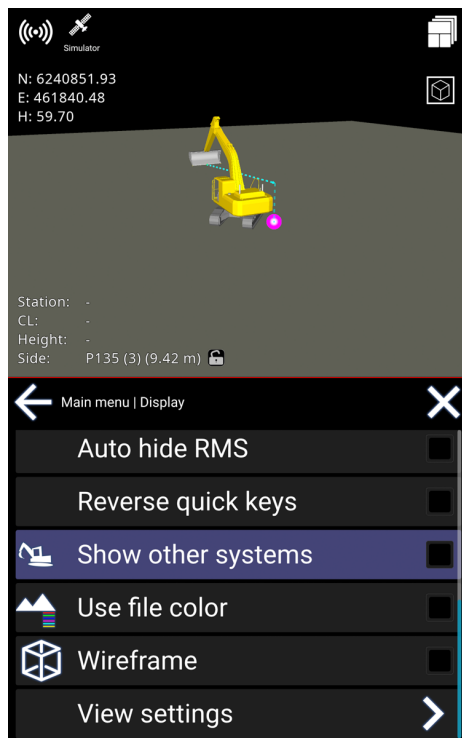

## 5.5. Show textures

Menu > Display > Textures

Instead of using solid colors, you can have textures shown. This is only possible with road geometry.

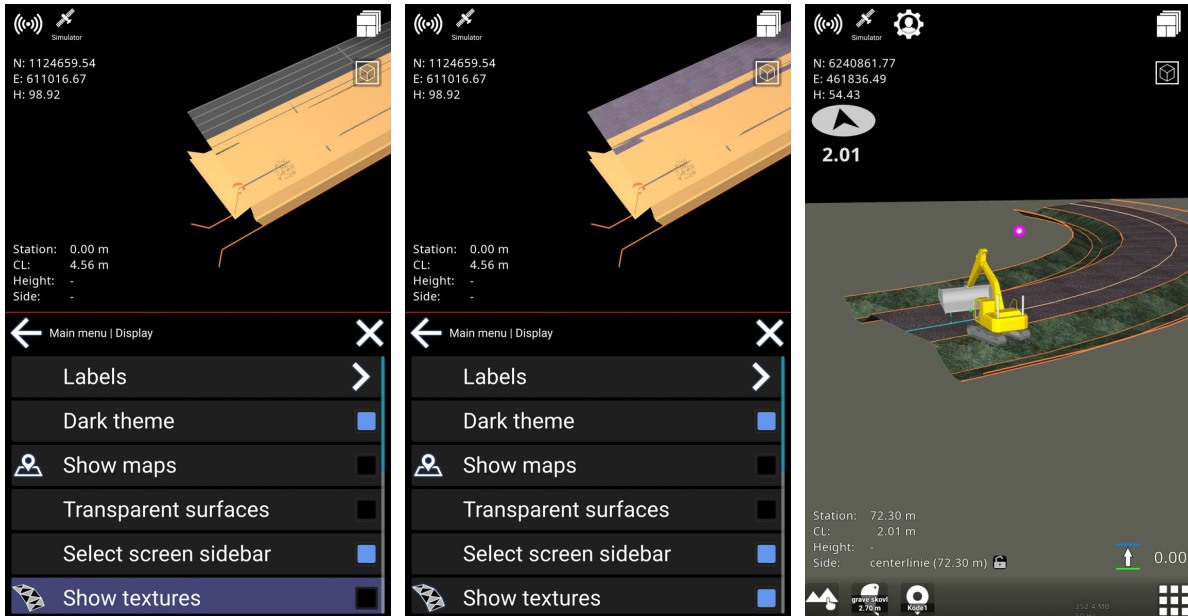

## 5.6. Tool point coordinates

Main menu > Display > Tool point coordinates

You have the option to show or hide the tool point coordinates in the app. When activated, the coordinates for north and east will be displayed along with the height. If deactivated, only the height will be shown.

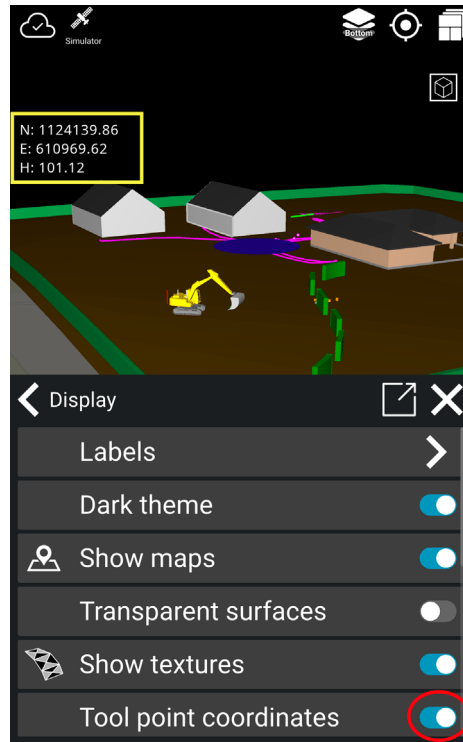
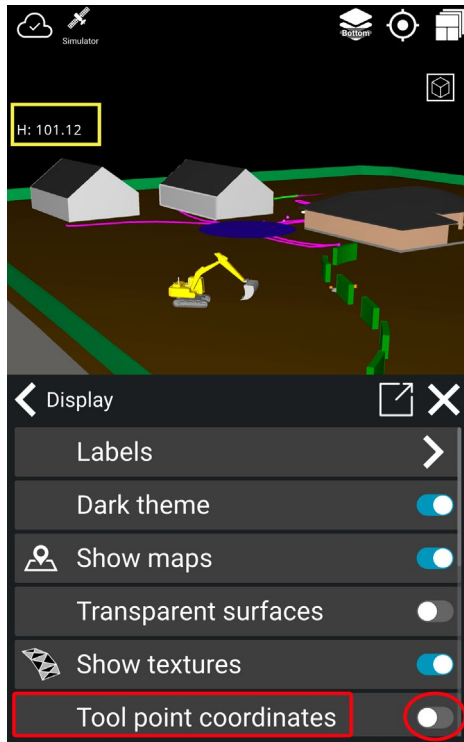

## 5.7. Machine speed

This feature **'Machine speed'** shows the speed of the machine, working like a speedometer. The speed is displayed in kilometers per hour (km/h). When activated, the speed will appear in the top left corner.

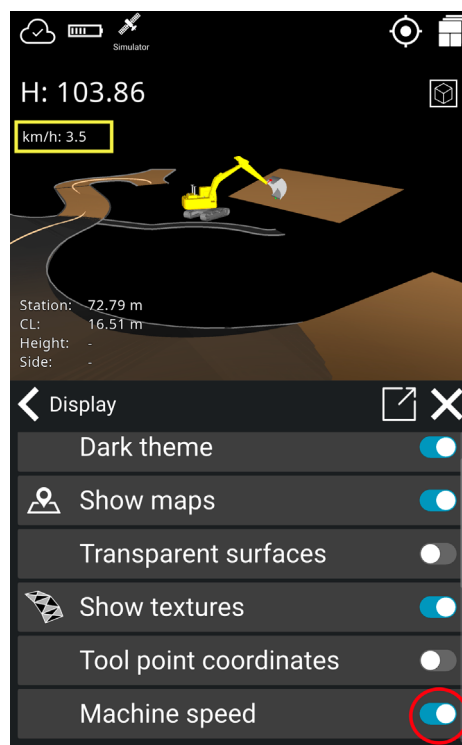
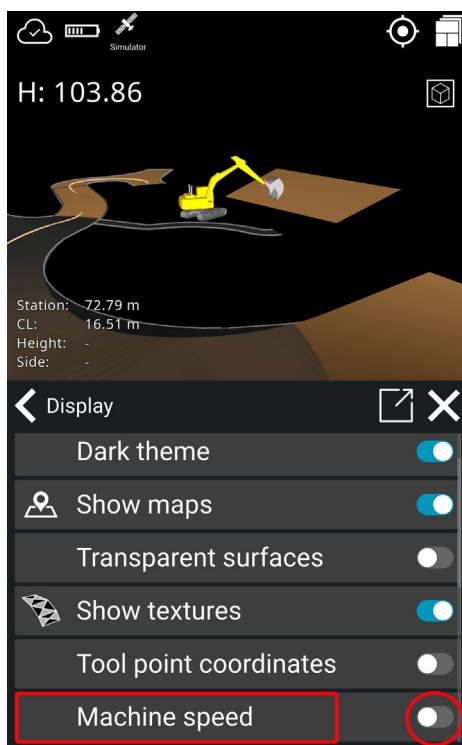



## 5.8. Auto hide quick keys

Menu > Display > Auto hide quick keys

Auto Hide Quick Keys will hide the “quick keys” at the bottom of the screen after about 8 seconds of not touching the display.

When you touch the display, they become visible again. It will give you a clearer view of what you are working on when icons are hidden.

## 5.9. Reverse quick keys

Menu > Display > Reverse quick keys

This feature places the quick keys to the right of the menu button. It makes it more convenient to log points from the right-hand side of the screen without having to visually locate the point logging feature.

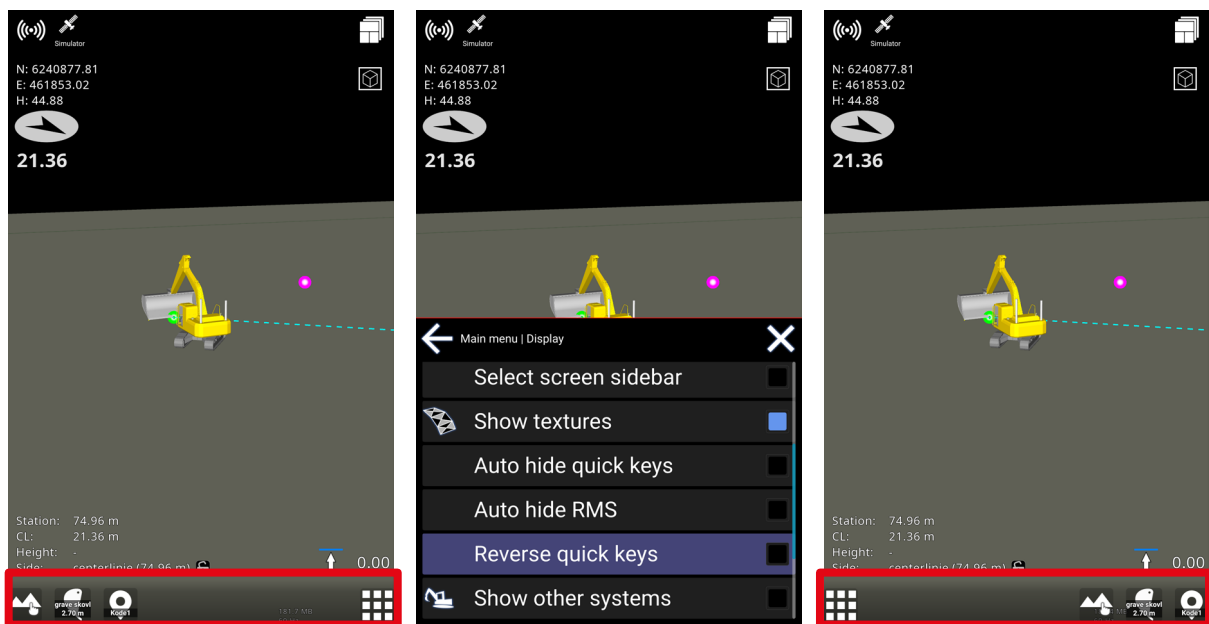

## 5.10. Transparent surfaces

Menu > Display > Transparent surfaces

Hide the surfaces to be able to see lines and points beneath them.

Note: Surfaces with textures will not be transparent.

Warning: Reference selection is not visible when transparent surfaces are enabled.

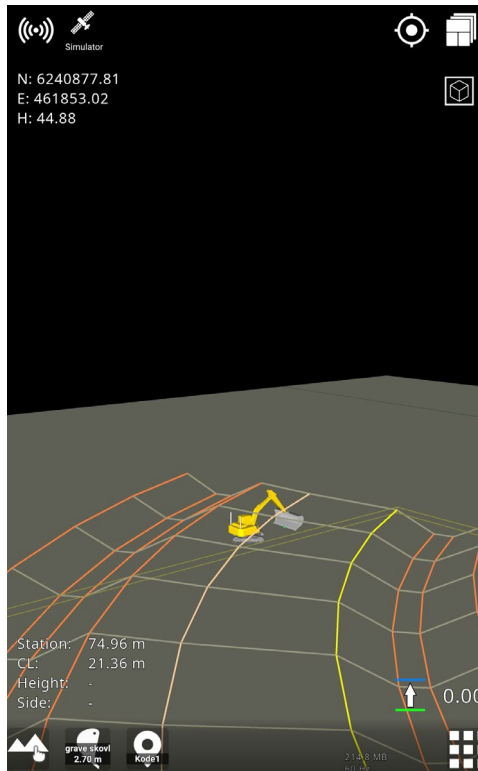

## 5.11. Dark theme

### Menu > Display > Dark theme

By default, the machine control system has the 'Dark theme' enabled, which is great at nighttime or when working in dimmed conditions. It is recommended to disable this feature when working in a bright environment, especially while working in direct sunlight when staking out points outside the cabin, etc.

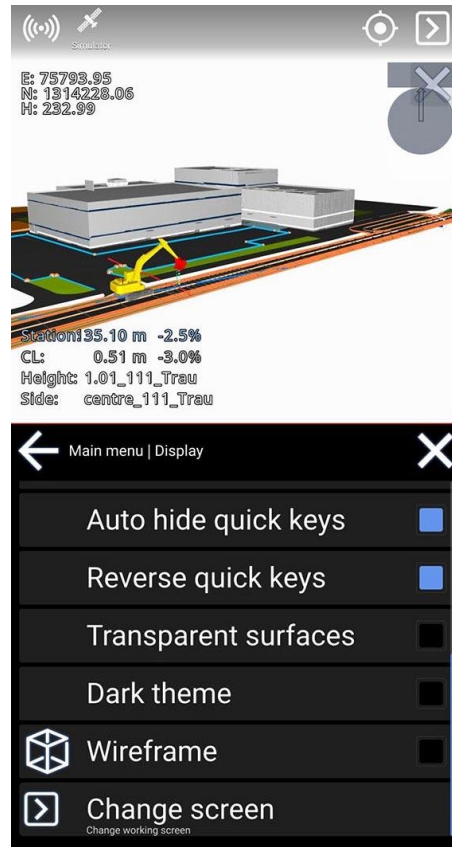
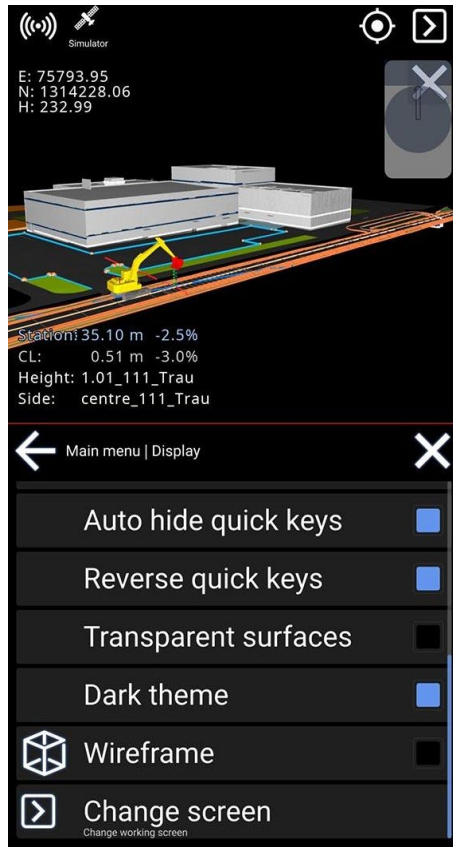

## 5.12. Wireframe

Menu > Display > Wireframe

Tap **Wireframe** to enable the triangular design to be visible. This will show the edges of the triangles and might improve their visibility.

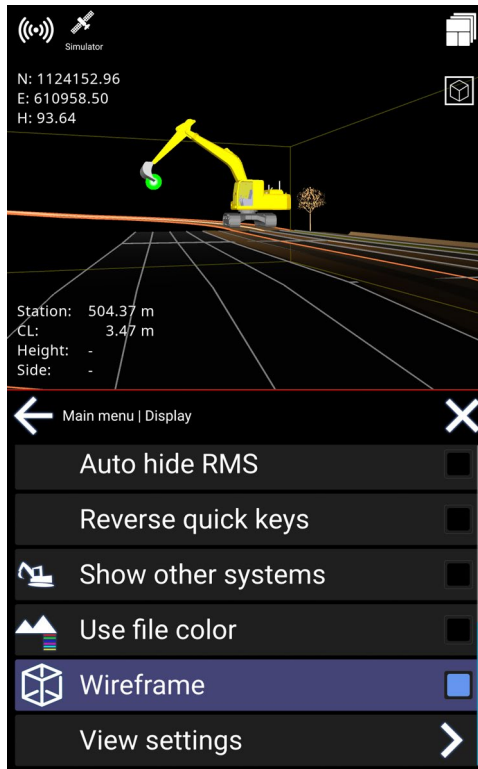

## 5.13. View settings

**Menu > Display > View settings**

To obtain a better overview of your work, you now have the option of hiding the excavator or making it transparent.

Open the menu and select **Display**. Scroll down to **View settings**.

It is possible to set this individually for a work situation or when you touch the screen. You can also choose individual settings for runscreens with 3D View or Top View.

You can now easily toggle between 3D View and Top View by pressing the icon in the upper right corner.

## Menu > Display > View settings > Top view

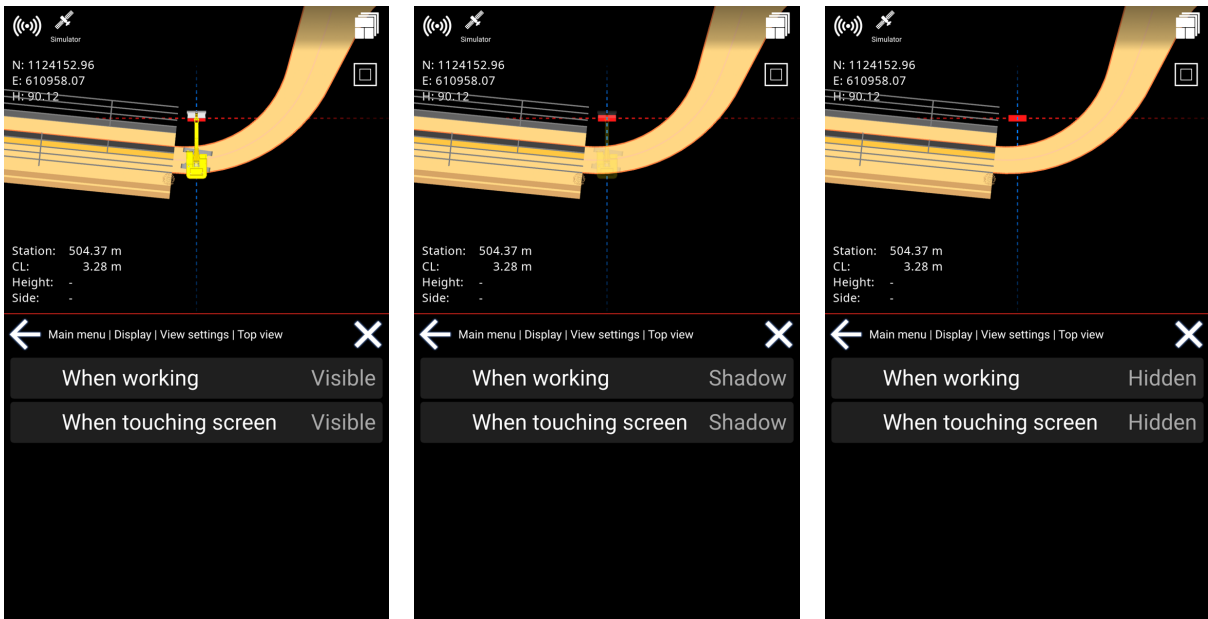

## Menu > Display > View settings > 3D view

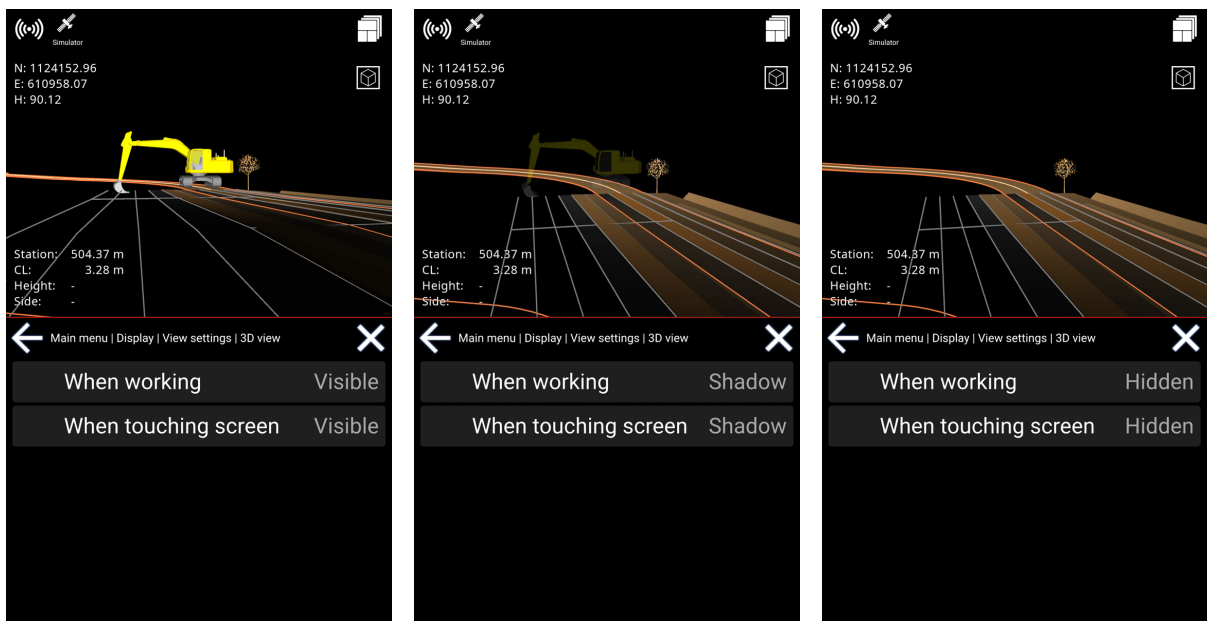

## 5.14. Change screen

This option is to change the working screen. Tap the icon in the top right corner and select the workscreen option you want to display.

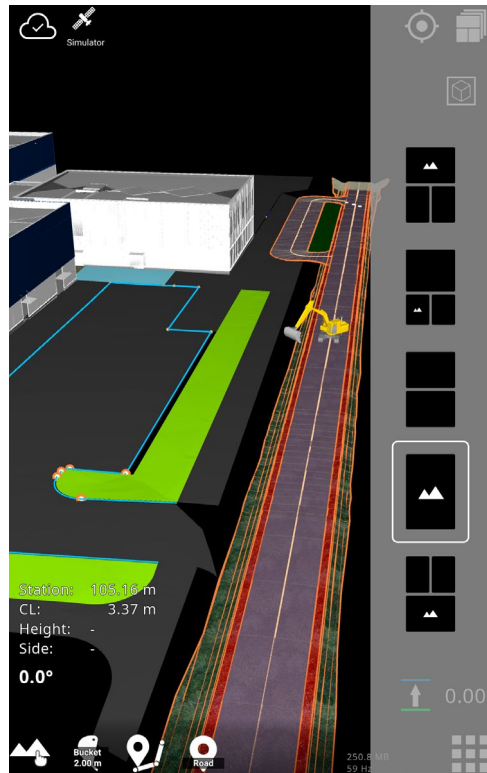
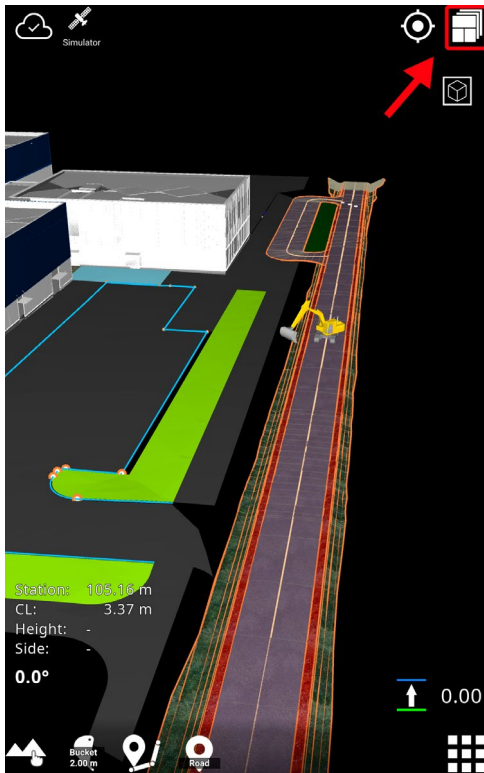

# 6. Settings

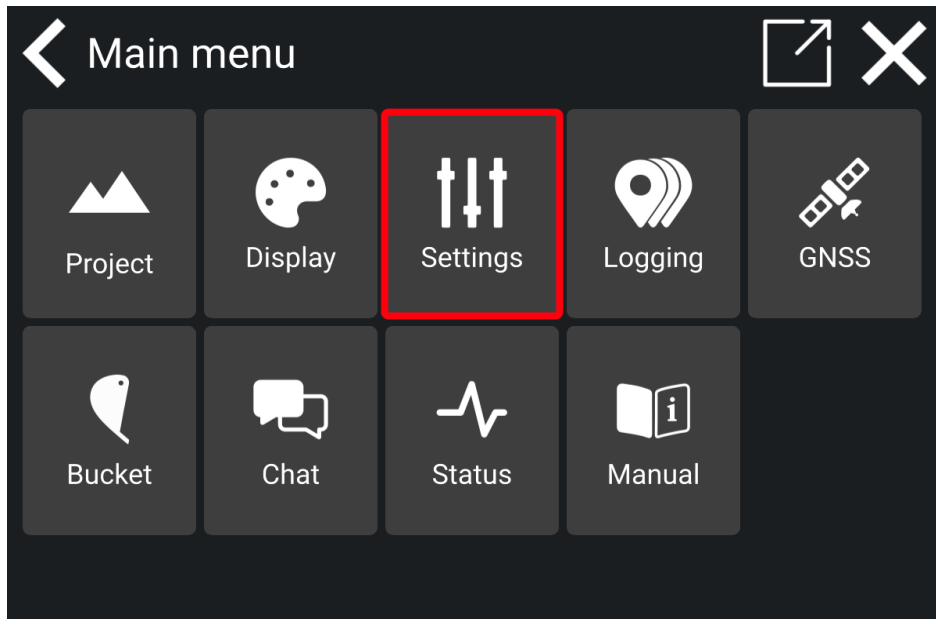

## 6.1. Tolerances

Tolerances are thresholds for calculations. They are used for different indications, like colors and sounds. You can change the tolerances for height, side, and alert.

When working outside the specified tolerances, the indicator in question is shown in white color.

### 6.1.1. Height tolerances

- 1) Tap 'Height'.

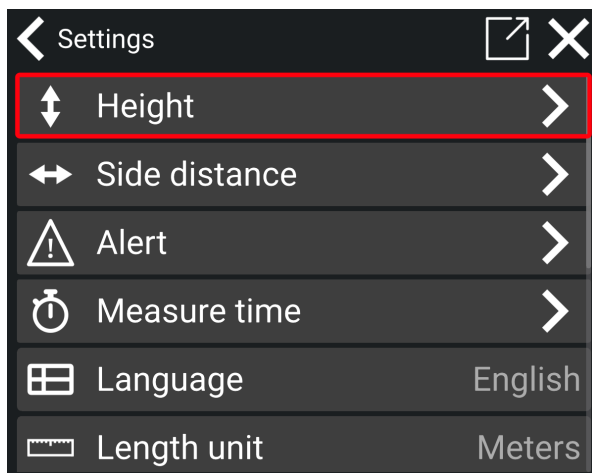

2) Tap 'Height tolerance'.

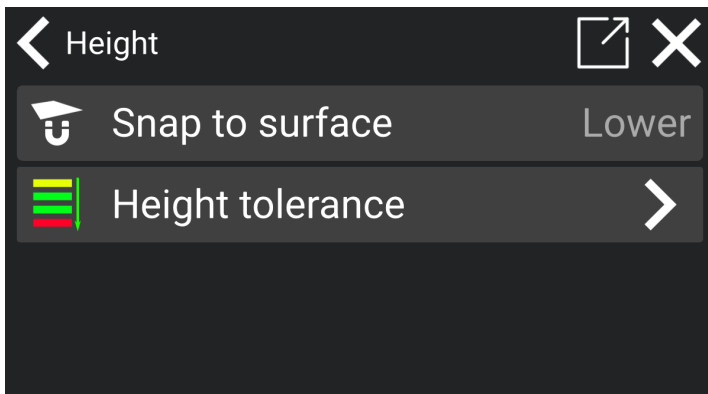

3) Choose any of the 3 options (Red, Yellow, Green).

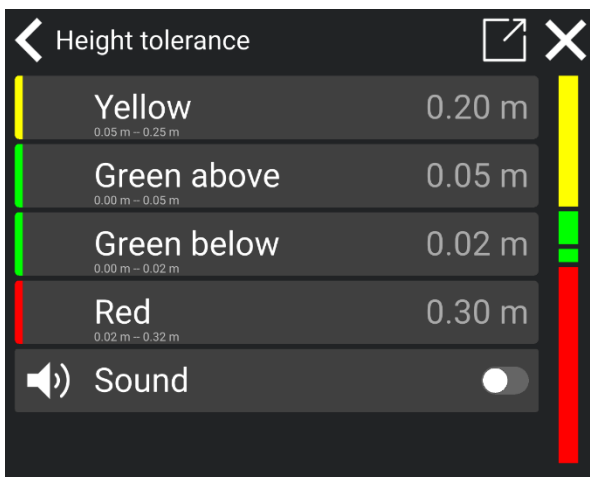

4) Enter the tolerance.

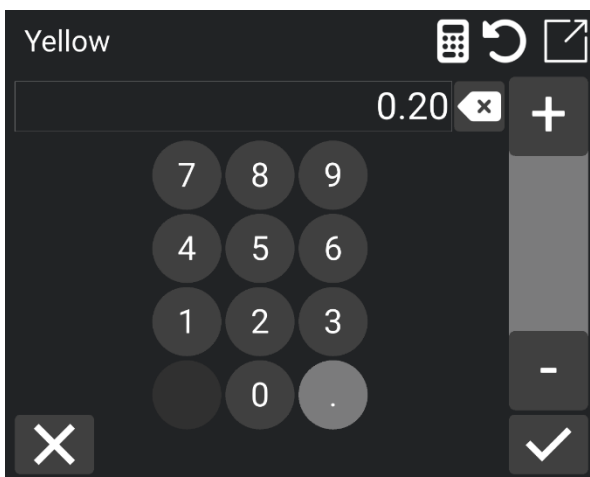



The 'Yellow' band for the height tolerance indicates a distance for when to start showing that you are near a selected height reference.

'Green above' and 'Green below' are the limits for the accepted height deviation, respectively above and below the reference. As long as your measurements fall within these green zones, the deviation is within the allowed range, and the job meets the required standards.

'Red' is an indication of excavating too deeply into the ground. The tolerance is an expression for when to ignore the warning when you are far below the reference.

The sound option will enable different sounds depending on the band within which you are working. There will be no sounds when working above the yellow band and below the red band.

#### 6.1.1.1. Snap to surface

If you have multiple height references activated, you can select whether the tool point should snap to the lowest or the highest surface. This means that when height references for multiple layers are active, the tool point will automatically snap to either the lowest or the highest surface, depending on your chosen setting.

- 1) Go to **Settings > Height**.
- 2) Tap on 'Snap to surface'.

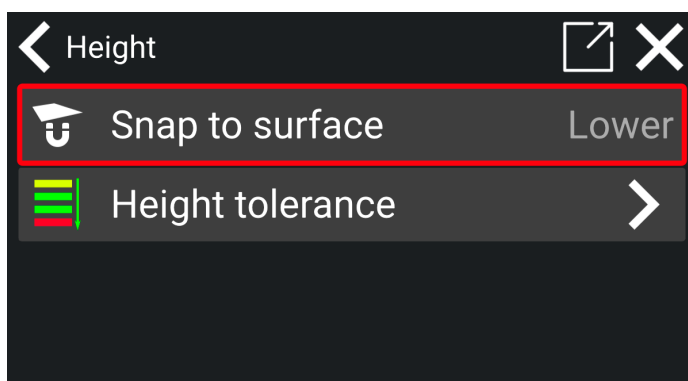

- 3) Choose between 'Lower' and 'Upper' to snap to the lowest or highest surface depending on your preference.

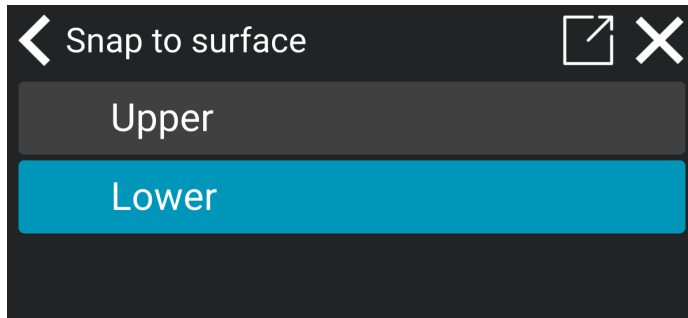

4) The tool point will now snap to the lowest or upper surface depending on your chosen setting.

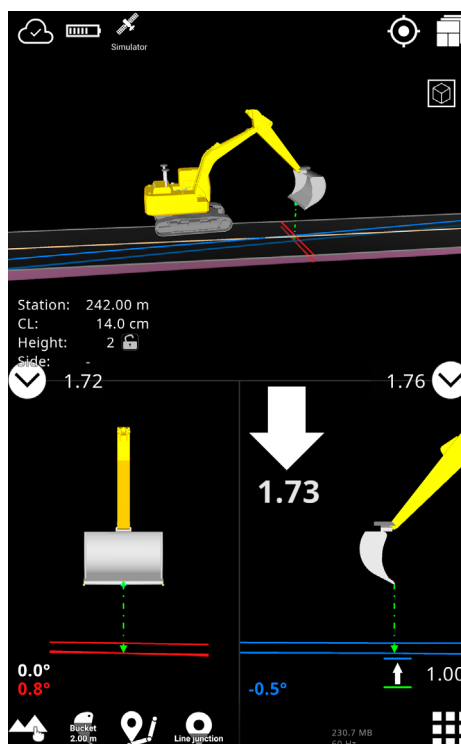

### 6.1.2. Side tolerances

For the side distance, 'Red' means that you are approximately within reach of your target, and 'Yellow' means that you are even closer. The 'Green' band indicates the accepted deviation from the target.

Keep in mind that the side distance is calculated horizontally and is not the shortest path.

1)

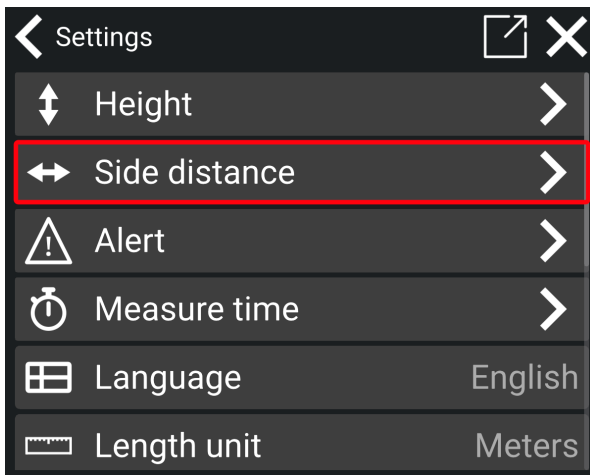

2)

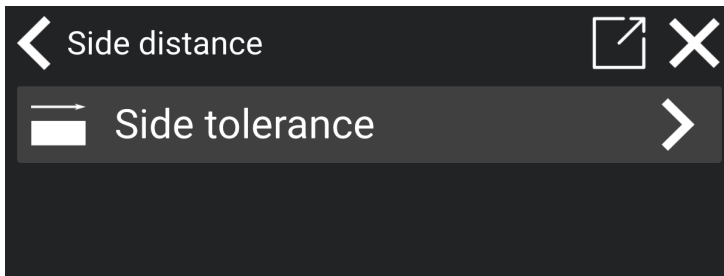

3) Choose any of the 3 options (Red, Yellow, Green).



4) Set the tolerance.

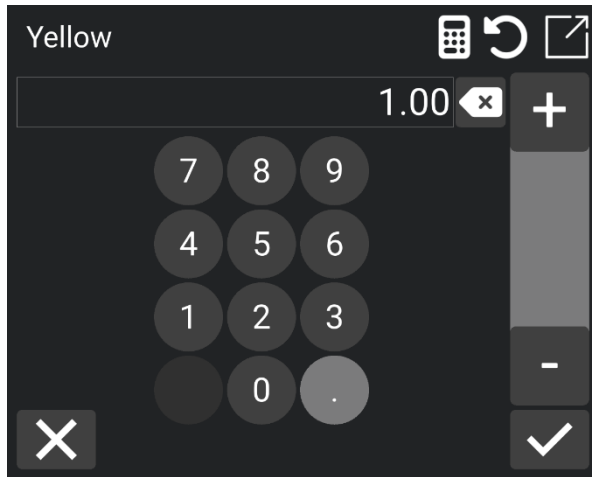

### 6.1.3. Alert tolerances

The tolerance for alert is divided into *Show*, *Warning*, and *Danger*.

- If you are in the 'Show area', a red 3D line will be shown.
- If you are in the 'Warning area' you will get a warning notification saying, "Too close".
- If you are in the 'Danger area' you will get a danger notification, and an alarm will sound if turned on.

1)

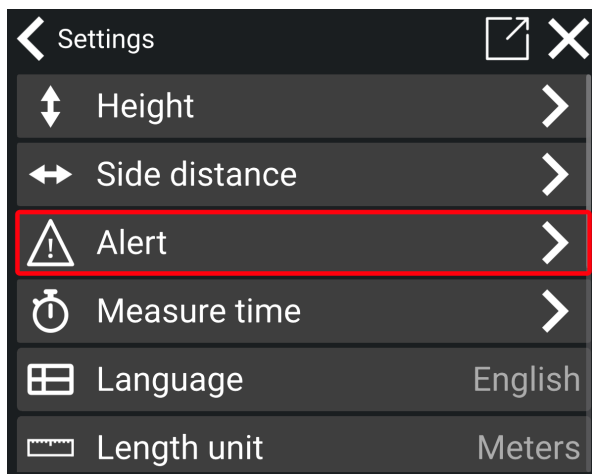

2)

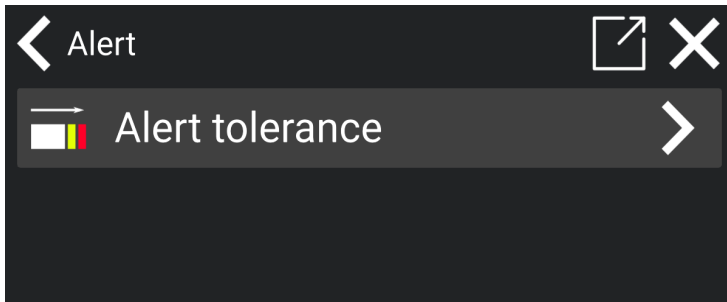

3) Choose any of the 3 options (Show, Warning, Danger)

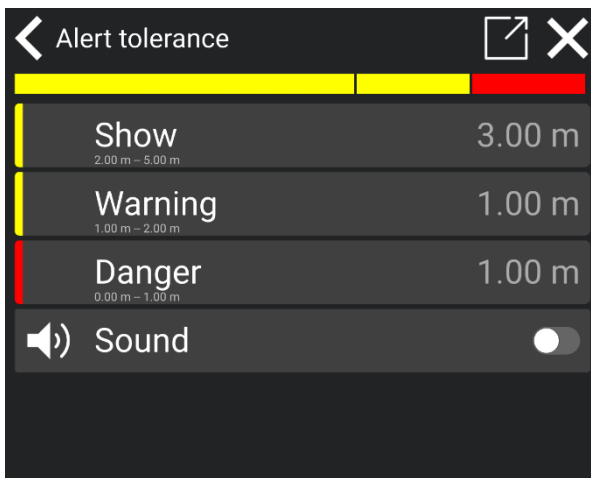

4) Change the distance you want from the point of alert.

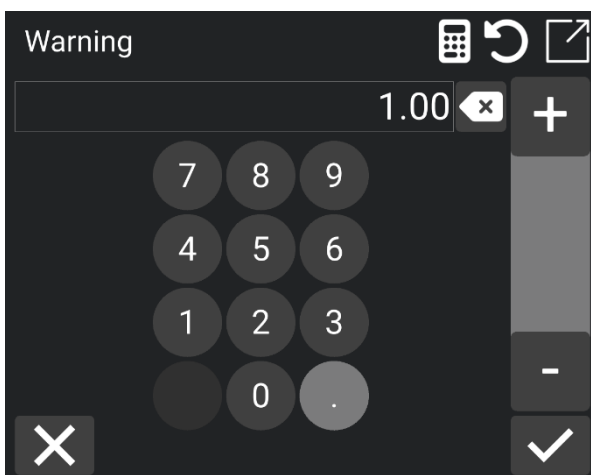

You will have a sound option as well. Activate the button for sound or deactivate it for mute sound.

## 6.2. Measure time

Main menu > Settings > Measure time

For the most accurate measurement in the Makin' 3D app, you can adjust the measured time settings. You can also improve accuracy by allowing the sensors to stabilize and reducing surrounding noise from GNSS by delaying the measure time.

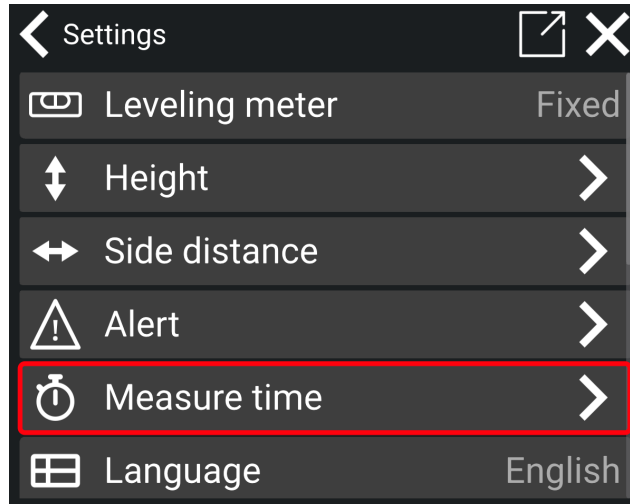

In the 'Measure time' menu, you will see two functions: **Measurement time** and **Delay time**. These settings allow you to fine-tune the measurement process for the most precise results. Learn more about how to use these settings in the following paragraphs.

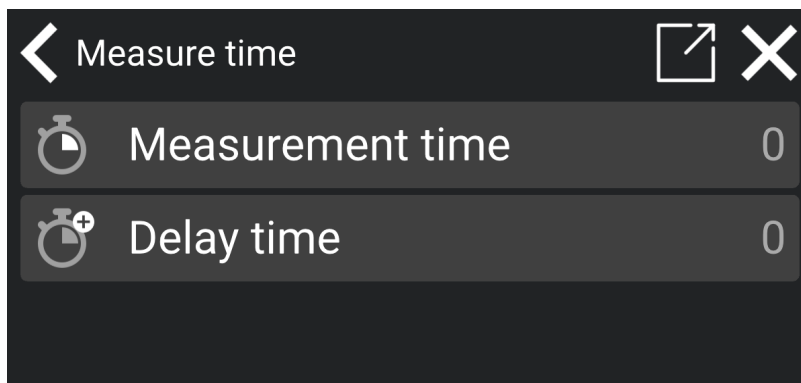

## 6.2.1. Measurement time

When you use the 'Measurement time' function, you can specify a duration for the Makin' 3D app to measure. This feature accounts for GNSS fluctuations by averaging the data for greater accuracy. For instance, if you set the measurement time to 1 minute, the app will calculate the average position after one minute for a more precise reading.

- 1) Tap on **Measurement time**

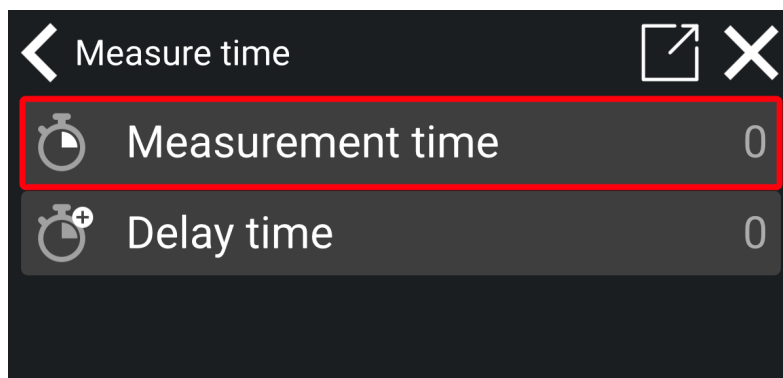

- 2) Set your desired measurement time.

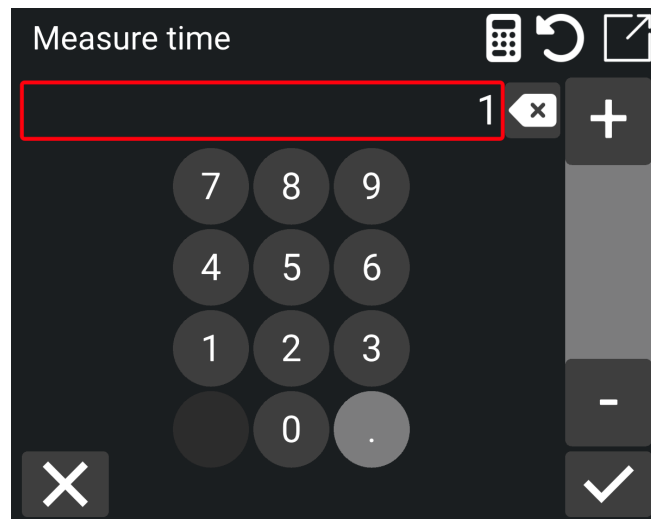

- 3) Tap on the check mark to save.

## 6.2.2. Delay time

With the 'Delay time' function, you have the option to postpone the measurement process in the app. This delay allows the sensors to stabilize before capturing your position, leading to more accurate results. For instance, setting a 2-minute delay means the app waits for 2 minutes before starting to measure your position.

- 1) Tap on **Delay time**.

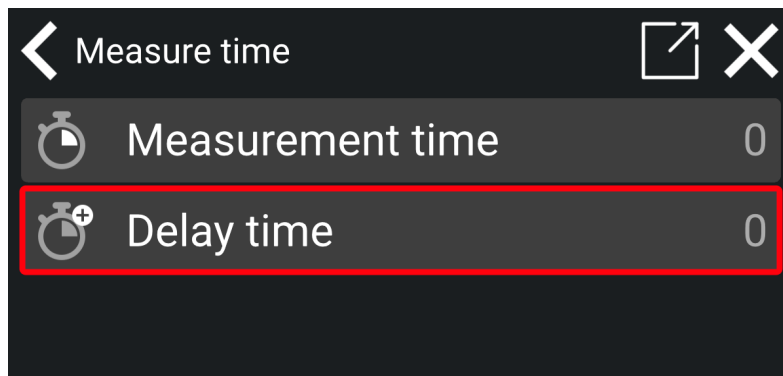

- 2) Set the desired delay time.

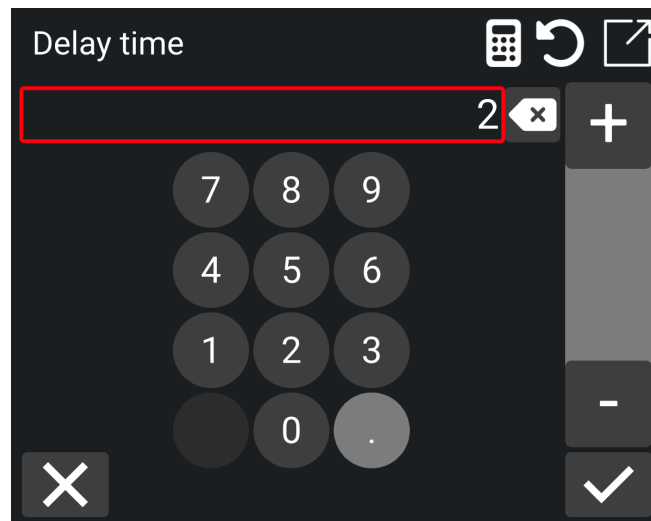

- 3) Tap on the check mark to save your selection.



## 6.3. Language

Menu > Settings > Language

Select the language of your choice. The language is automatically changed and saved.

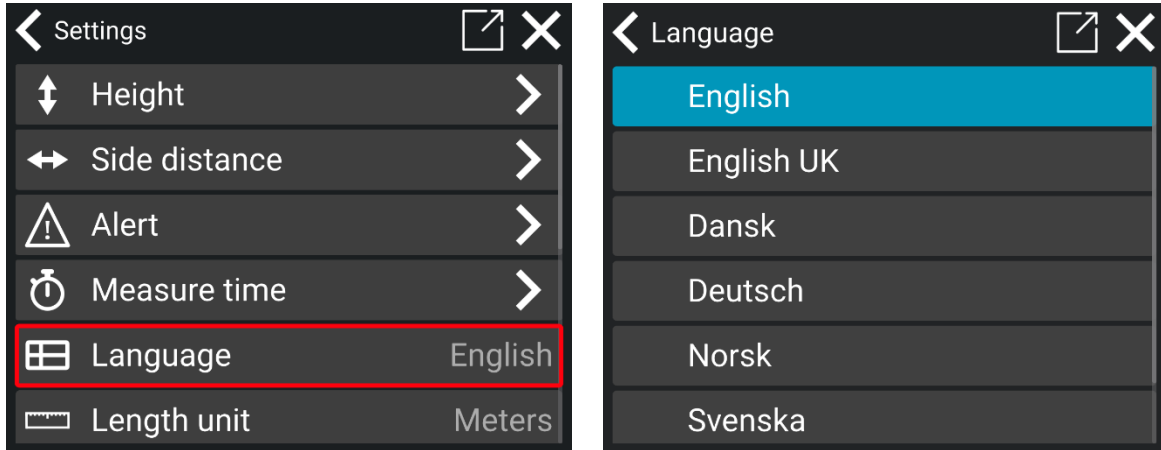

## 6.4. Length unit

Menu > Settings > Length unit

Tap to choose the length unit. It is automatically changed and saved.

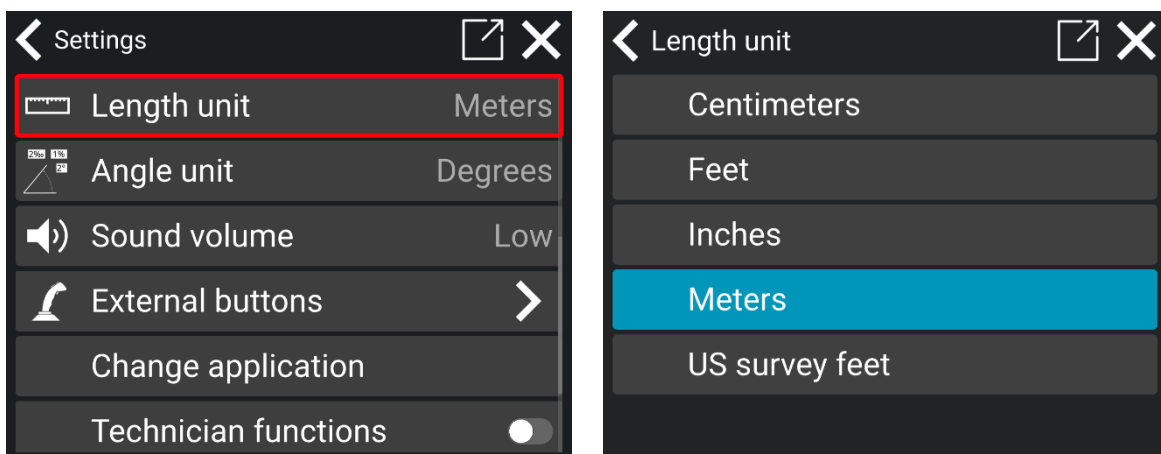

## 6.5. Angle unit

Menu > Settings > Angle unit

Tap to choose the angle unit. The angle unit is automatically changed and saved.

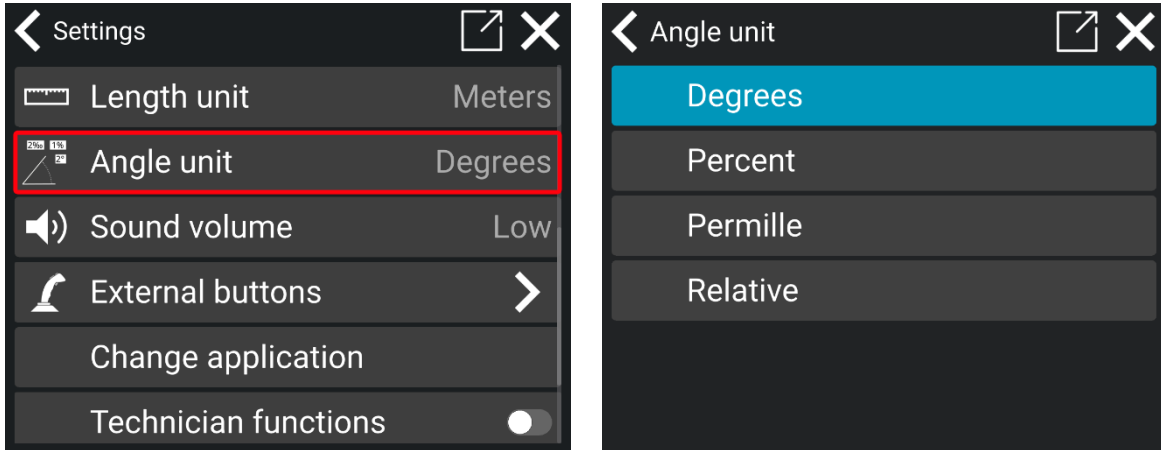

## 6.6. Sound Volume

Menu > Settings > Sound volume

Tap the sound volume again and again to change the sound level. Choices are given: *Low, Medium, High, Highest*.

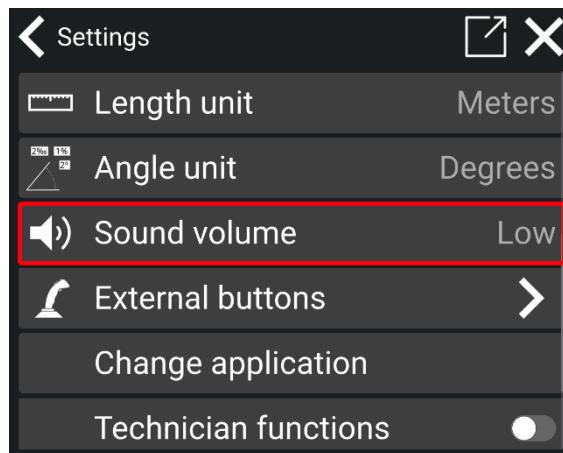

## 6.7. Area selection

Menu > Settings > Area selection

The '**Area selection**' feature makes selecting objects in areas with many elements (such as points, lines, or surfaces) easier. When you tap on an area with multiple elements, a list of up to 7 nearby objects will appear on the screen, which you can choose from by tapping on the object you want to select. The objects listed are the ones closest to the spot you have most recently tapped. A ring will briefly appear on the screen to indicate the area you are selecting.

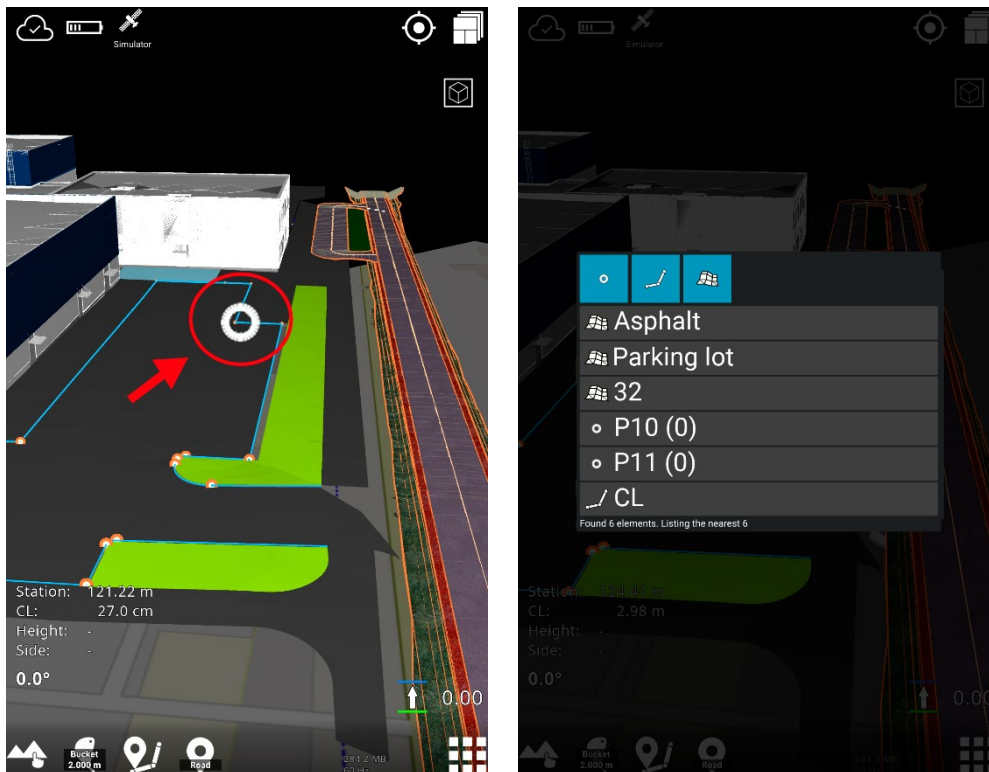

You can enable or disable this feature in the **Settings** menu. When 'Area selection' is disabled, only one object will be selected when you tap on the screen.

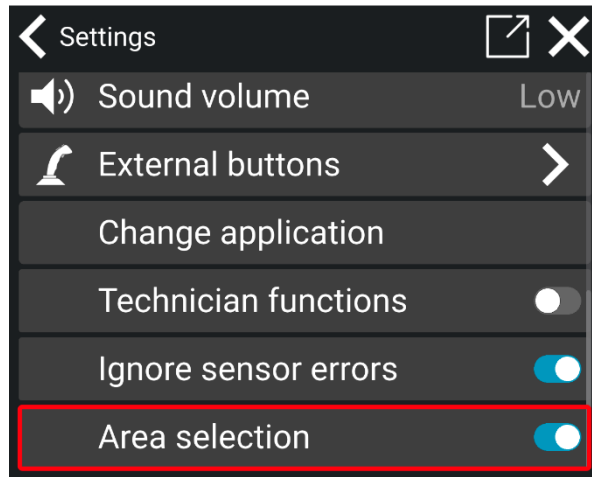

## 6.8. Leveling meter

Menu > Settings > Leveling meter

In the Leveling meter menu, it is possible to turn on or off the height indicator on corner tool points.

It is possible to select between *Fixed* or *Moving* arrows.

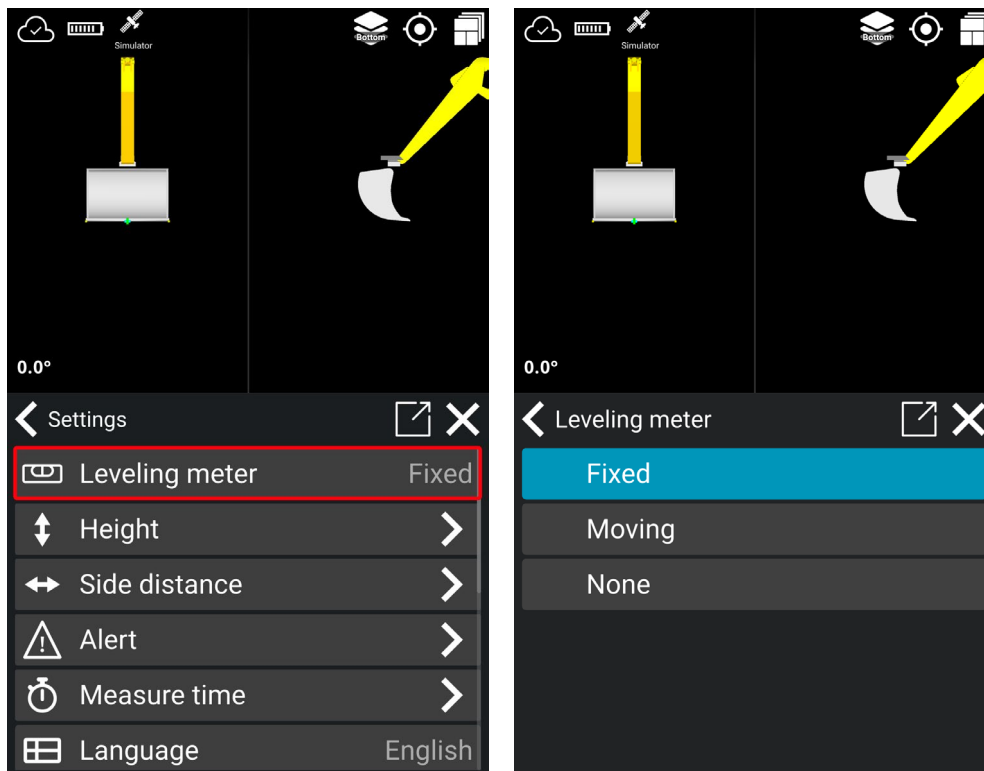

The green bars indicate the surface below the bucket when the plane has been selected.

The arrows and numbers in the circles indicate how far and in what direction you should move the bucket to match the surface below.



## 6.9. External buttons

**Menu > Settings > External buttons**

If you have a configurable joystick, you can set up the functionality here.

- 1) Choose the button you want to configure.
- 2) Choose between *No action*, *Change of tool point*, *Log point*, *Zero plane*.

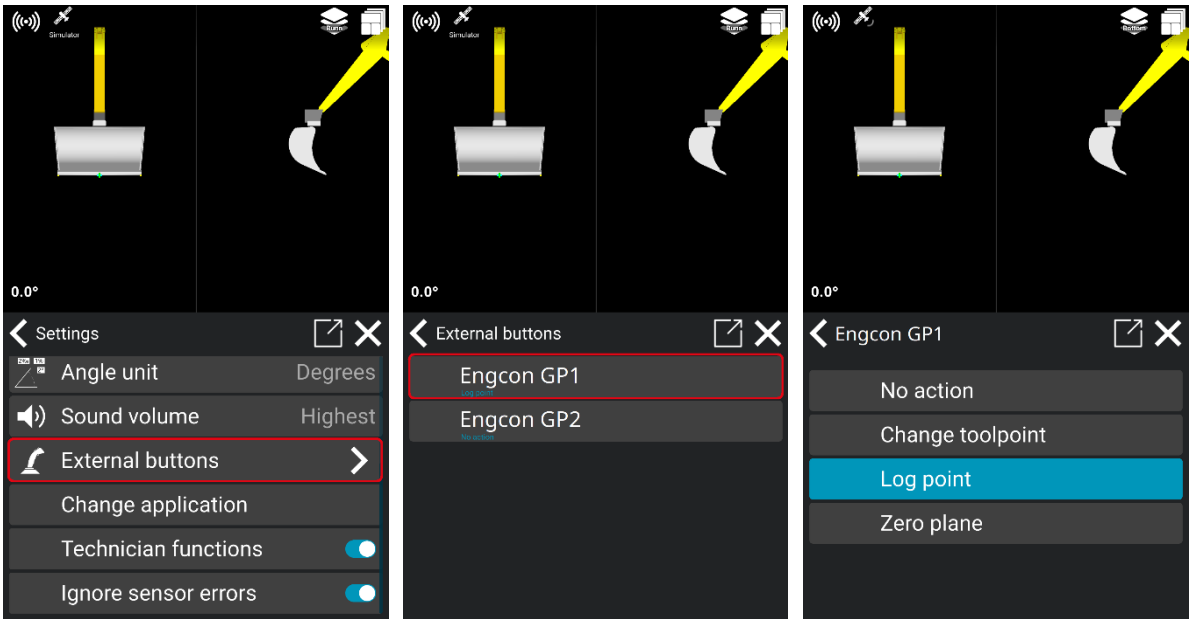

## 7. Logging (As-built)

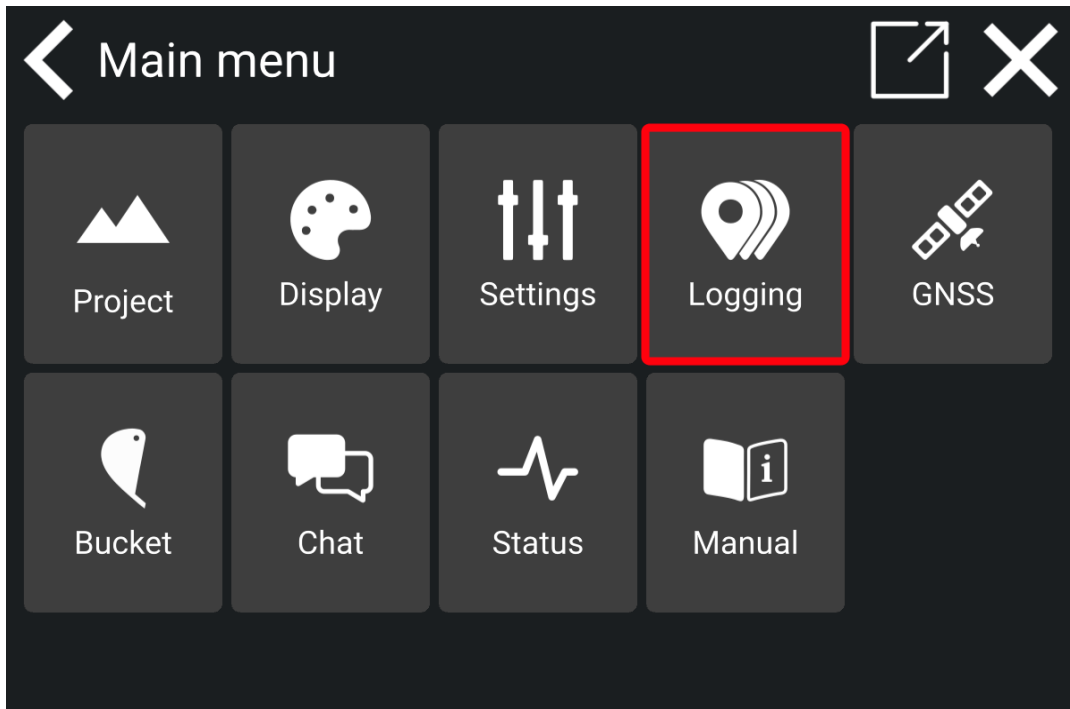

## 7.1. Log Point

Main menu > Logging

**Log Point** is an as-built feature used to document points. You can access it from the Logging menu or by long-pressing the shortcut on the work screen.

Option A

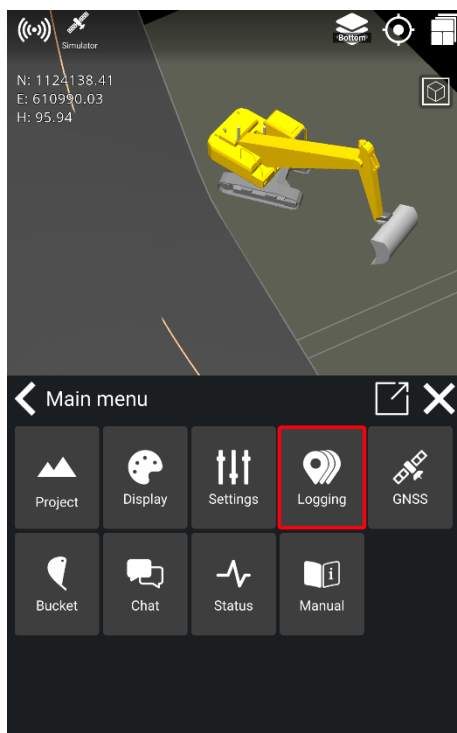

Option B

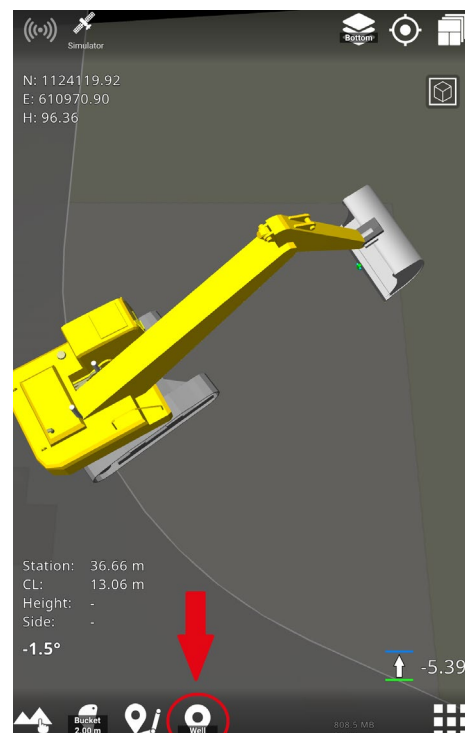

- 1) Tap '**Object**'. A list of your most recently used objects will appear.

If no objects are shown, click the **folder icon**, then select a group of objects to find the one you need.



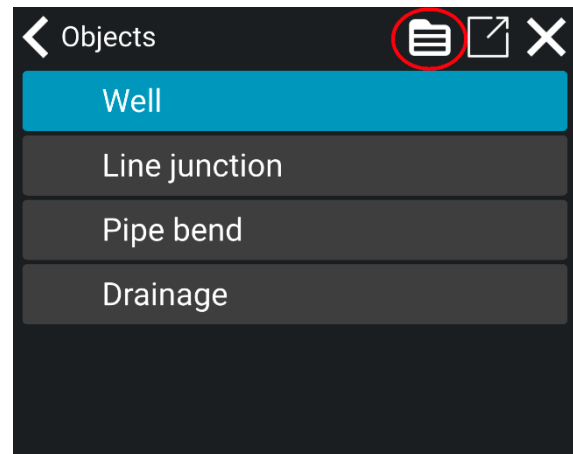
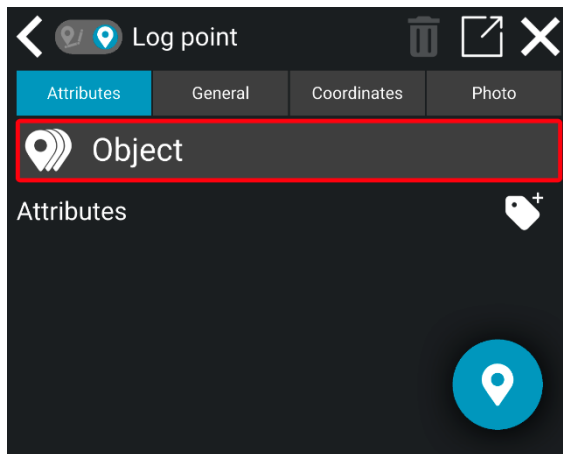

2) Choose the object group that suits your task.

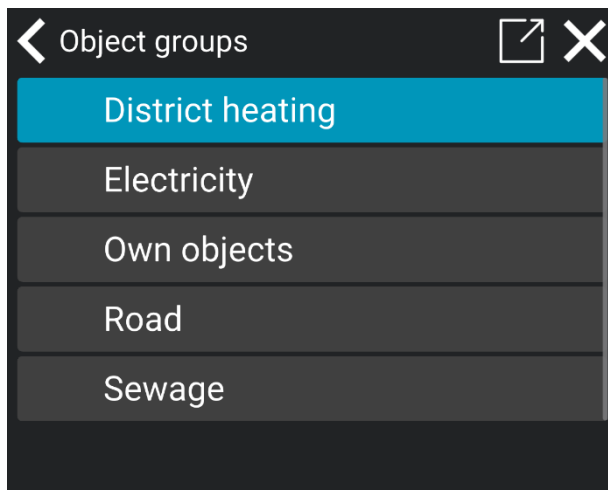

3) Select the relevant object from the list.

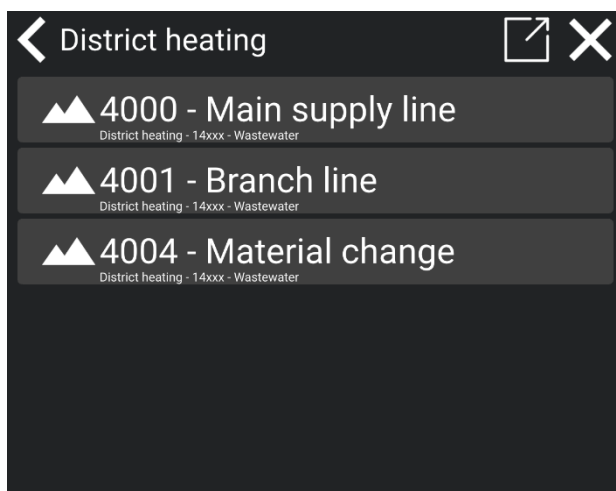

- 4) Once the object is selected, tap the **Log point** icon in the bottom right corner to log a point.

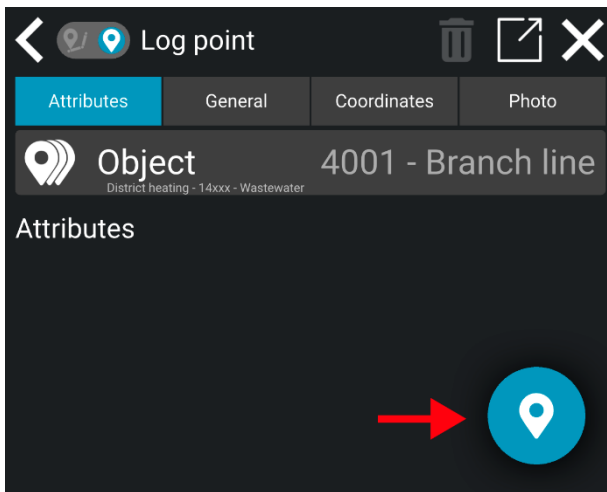

- 5) A notification will confirm the point has been logged, including the point number and object details.

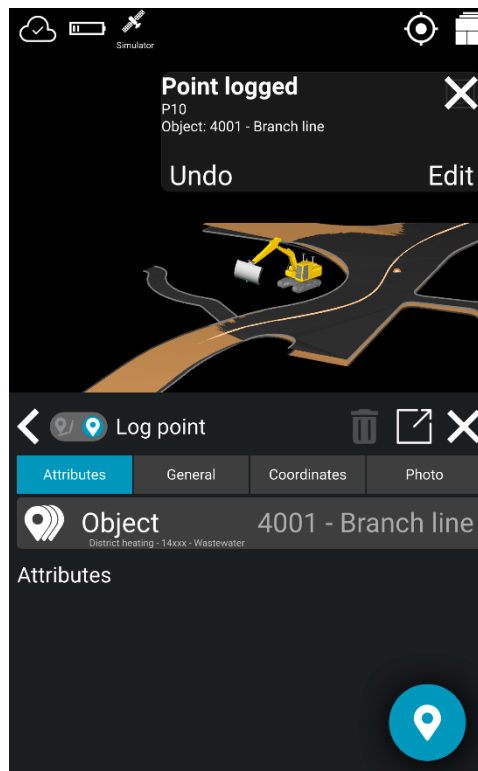

You can press **'undo'** if you regret your last logging. The confirmation pop-up will disappear after approximately 10 seconds.

*Note! The last used object will remain active until it is changed.*

## 7.2. Log Line

Log Line is an as-built functionality used to document how points are connected. Log Line can be used to document line breaks where there are changes in slope, direction, or if the project requires it, to document every line junction.

### How to log a line:

- 1) Press and hold the **Log line icon** at the bottom of the screen for three seconds

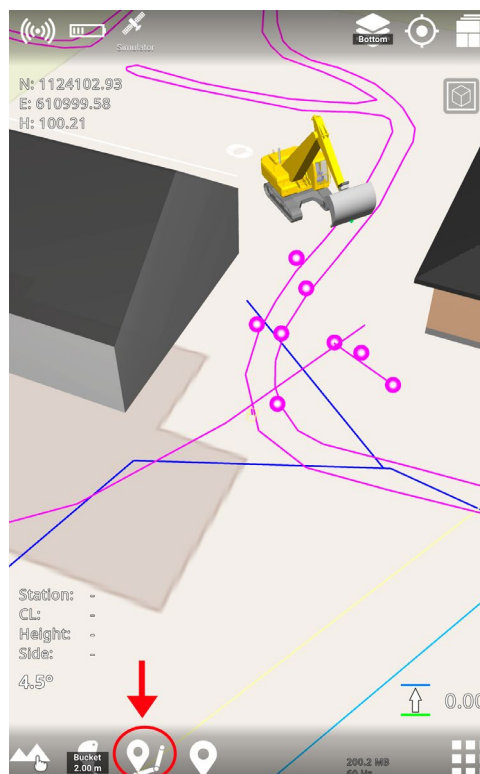

- 2) Choose the object that matches your task.

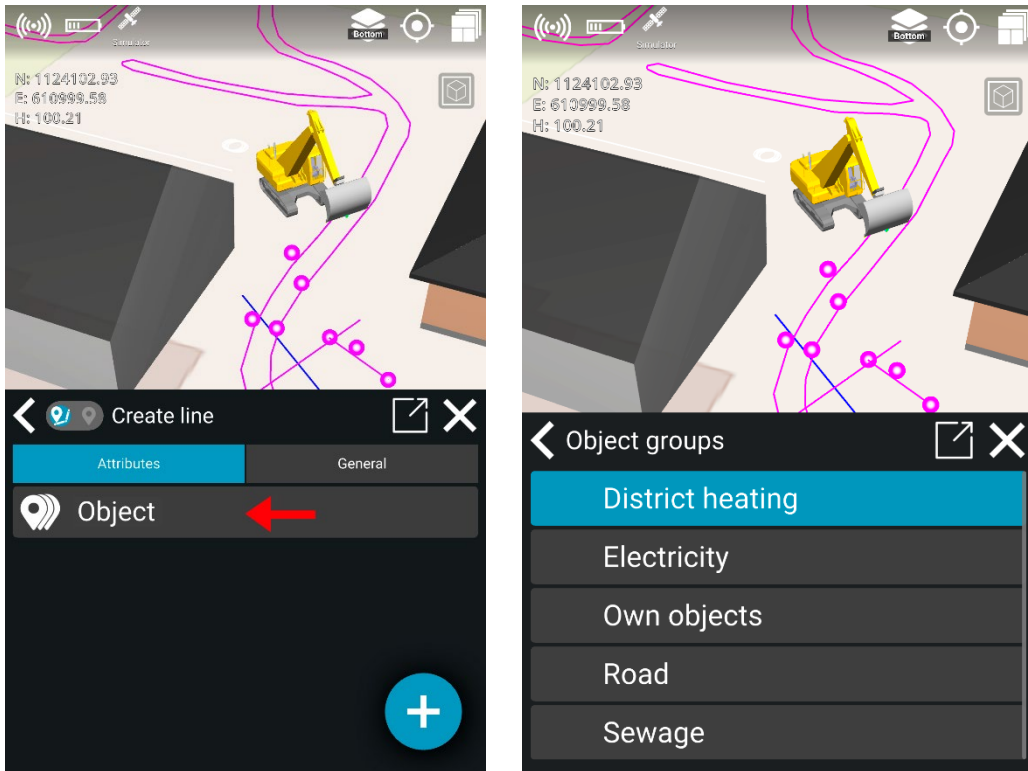

3) You can start logging a new line in one of two ways:

a. **Option 1:** By clicking the '+' icon located in the bottom right corner.

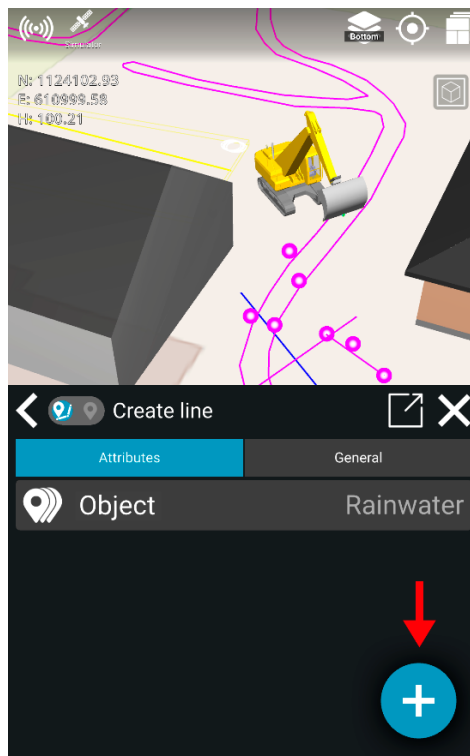

b. **Option 2:** Close the menu and then click on the log line icon on the work screen.

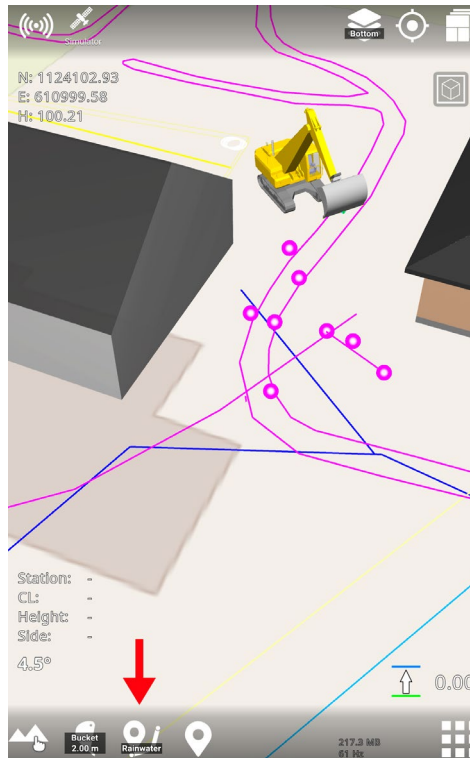

You can add line points by tapping the icon (see picture above).

- 4) To stop this line, press the **cancel log line** button at the top of the work screen. 

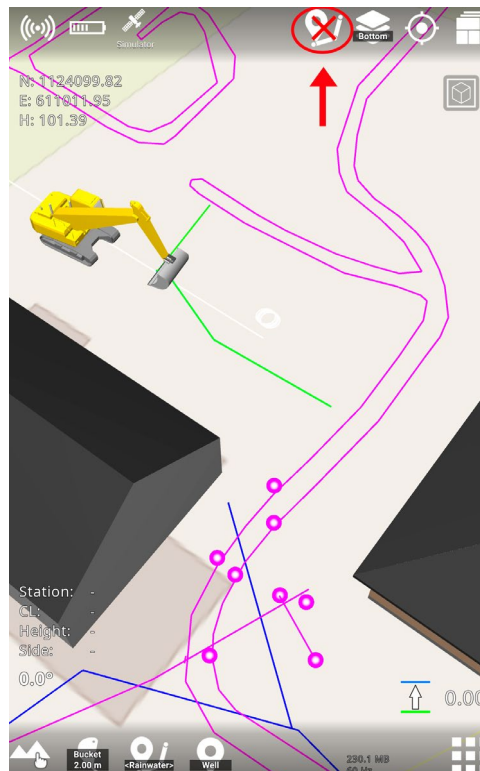

### 7.2.1. Log a new line from an existing line

It is possible to log a new line from an existing line. For example, you can easily log a line junction for a sewage project by logging a new line from an existing line.

#### How to:

- 1) Click on the line on the work screen, or go to **Project > References**, and activate the line by clicking on its name.

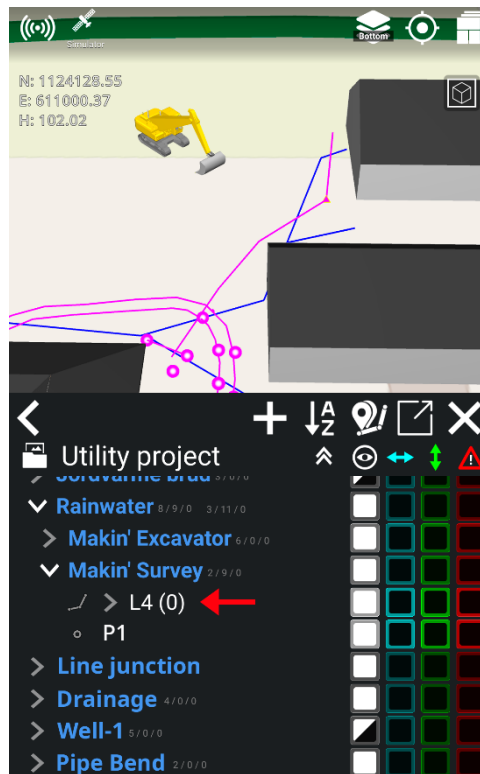

- 2) Click the gray arrow to expand the line and view the line points in the **Reference dialog**.

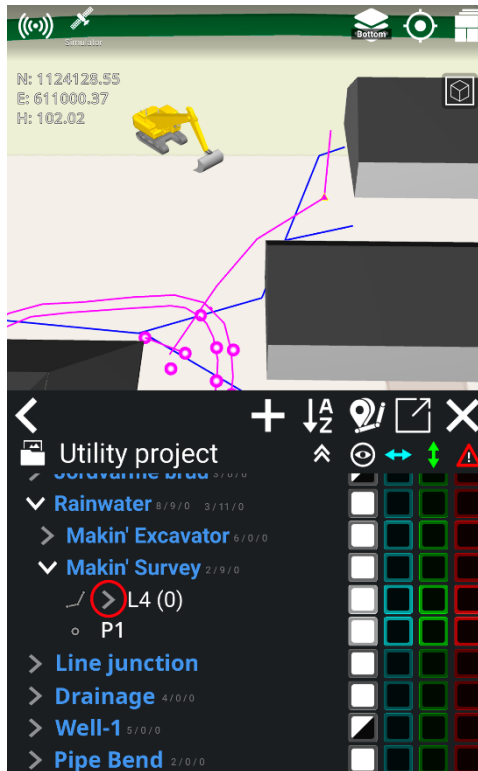

- 3) Choose the line point from where you want to start the new line and activate the line point by clicking on it.
- 4) Click on the 'Log line' icon.

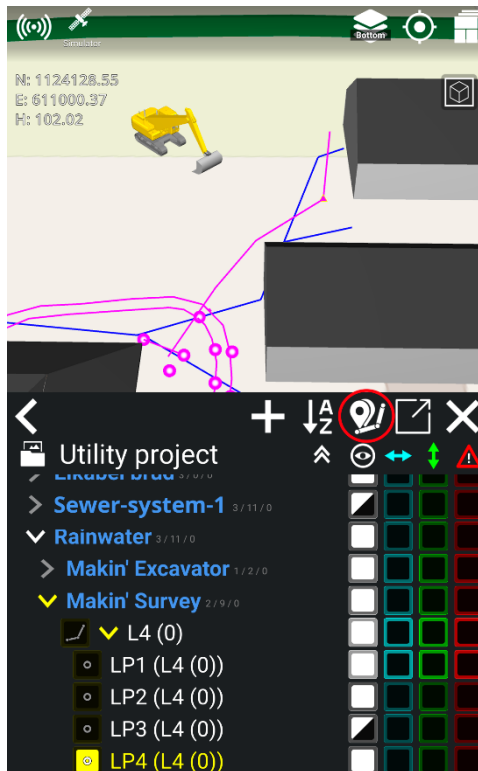

5) You can now log a new line from an existing line.

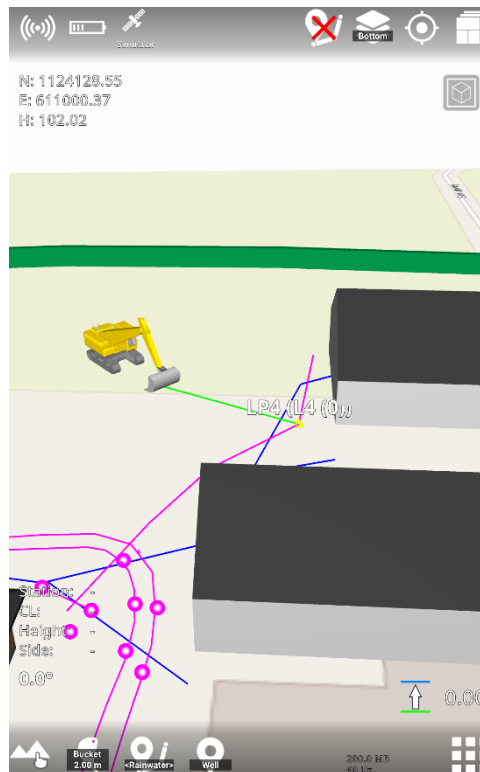

### 7.3. Swift between logging points and lines

You can log lines and points at the same time. You can, for example, log a line by short-pressing the **log line icon** at the bottom of your work screen, and when you want to log a point, you can simply short-press the **log point icon**. Even if you move the machine after logging a point, it remains in log line mode, allowing you to log points at the same time.



## Line logging-mode

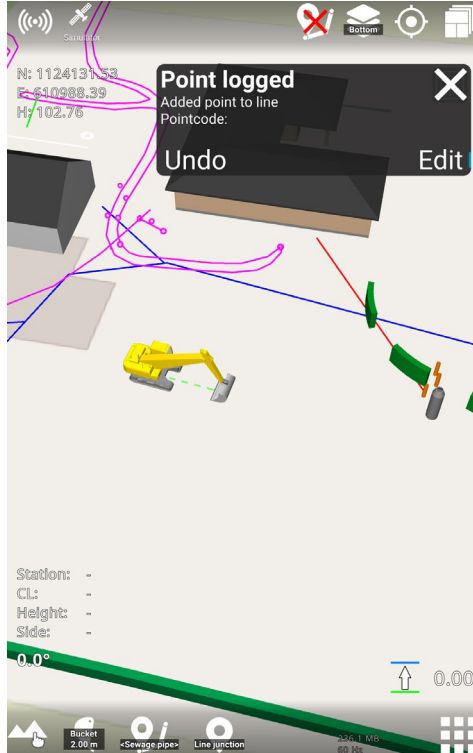

## Logging a point while logging a line:

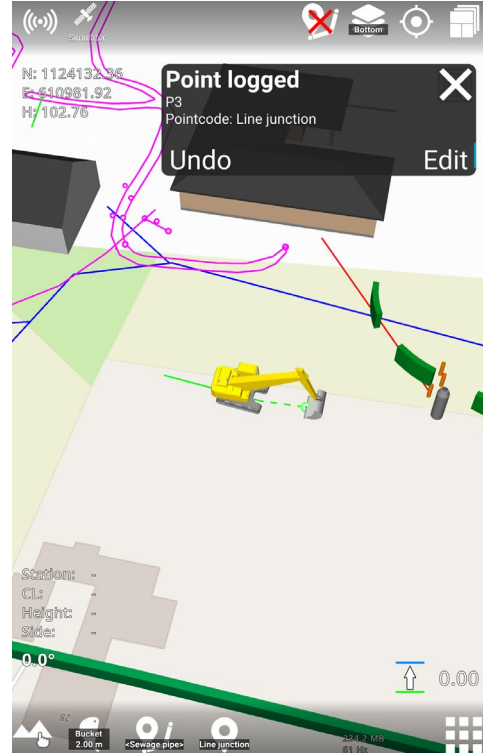

## 7.4. Own objects

Menu > Logging > Log point

You can create your own objects this way:

- 1) Select **Logging** in the menu.
- 2) Select 'Object'.

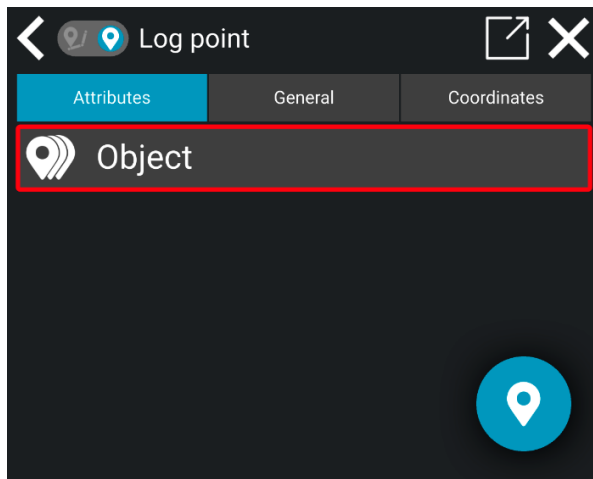

3) Tap the folder icon.

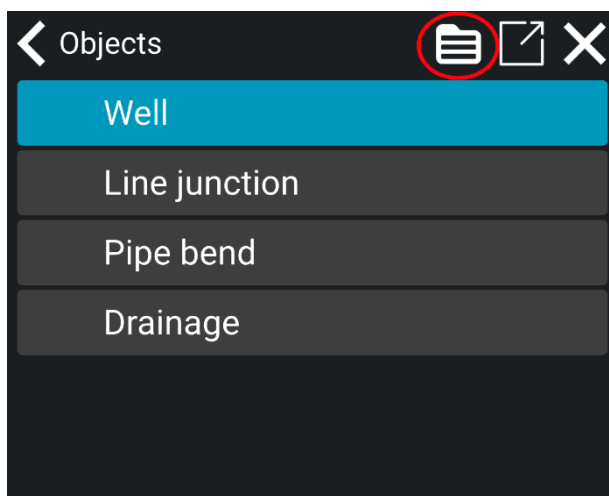

4) In 'Object group', select 'Own objects'.

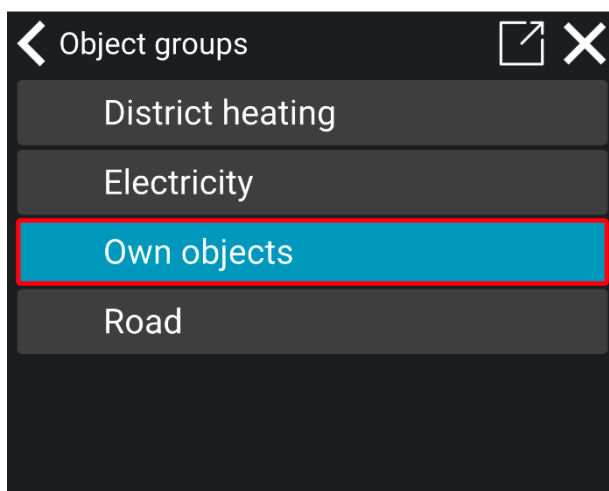

5) Tap '+'.



6) Name your object.

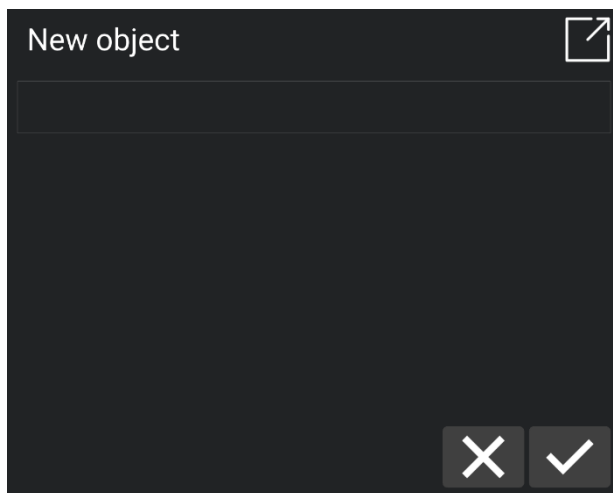

7) Tap the check mark to save.

The new object is now stored under '**Own objects**' and is automatically selected as the default object for point logging.

## 7.5. Attributes

If attributes have been created in Makin' Cloud, you can add them to the points, lines, and line points you want to log. For more details on creating attributes in Makin' Cloud, see section 7.8., *Create objects and attributes on Makin' Cloud*.

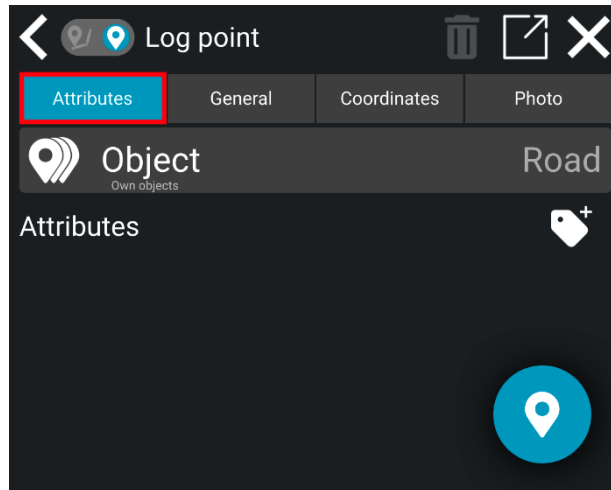

Attributes are characteristics and information that describe a logged point, line, or line point in as-built documentation. For example, attributes can include details like dimensions, materials used, or the type of measuring point, etc. The attributes you can use depend on the objects and groups that have been created for the project in Makin' Cloud.

#### How to add attributes:

- 1) Find the appropriate object for your task.
- 2) Select the attribute you want to add to the point or line.

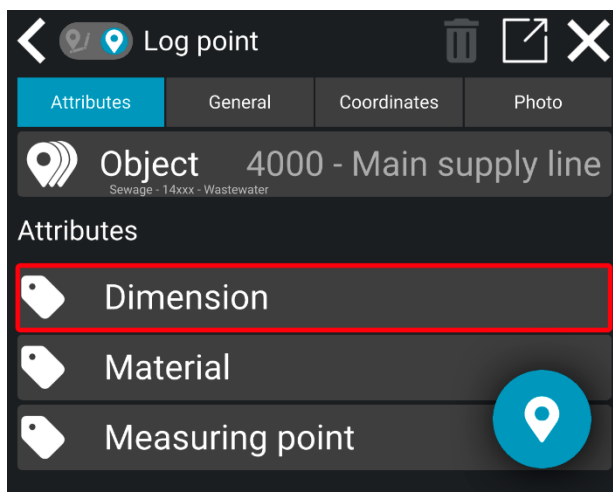

- 3) Enter or choose the relevant information for the attribute.



- 4) If needed, add more attributes by selecting them and filling in the details.
- 5) Tap the '**Log point/Log line**' icon in the bottom right corner.

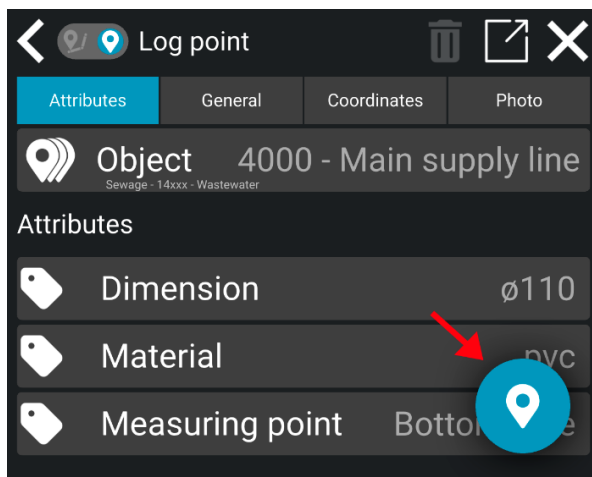

- 6) The point or the line is now logged with the added attributes.

### 7.5.1. Custom attribute

You can create custom attributes for your own objects in the Makin' 3D app. For example, a custom attribute can help make the office aware of an unknown cable or notify others about unexpected items.

- 1) Tap on '**Object**' and select '**Own objects**'.

- 2) Choose the object relevant to your task.
- 3) Tap the **attribute icon**.

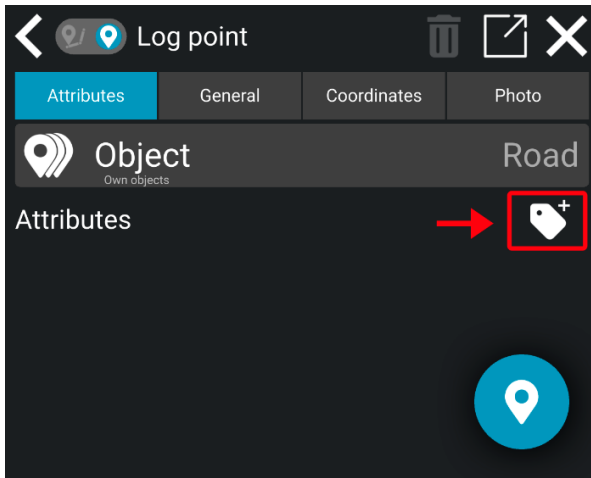

- 4) Enter the details for '**Title**' and '**Text**'.
- 5) Tap the '+' button in the bottom right corner.

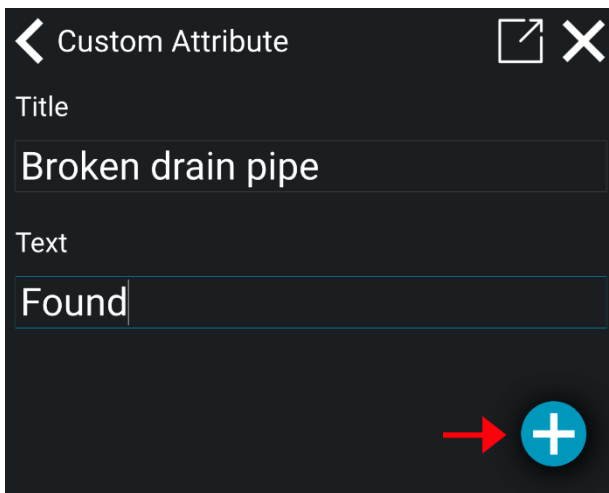

- 6) The custom attribute is now added to the object.
- 7) You can create and add more custom attributes if needed.
- 8) Tap the **Log button** in the bottom right corner to log the point or line.

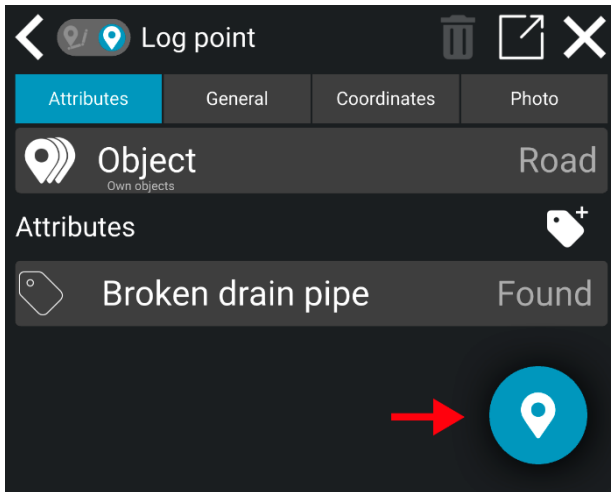

## 7.6. Log offset

**Main menu > Logging > Coordinates / Work screen > Long-press the Log point icon > Coordinates**

You can log an offset for both point and line point heights:

- 1) Go to **Coordinates > Log offset**

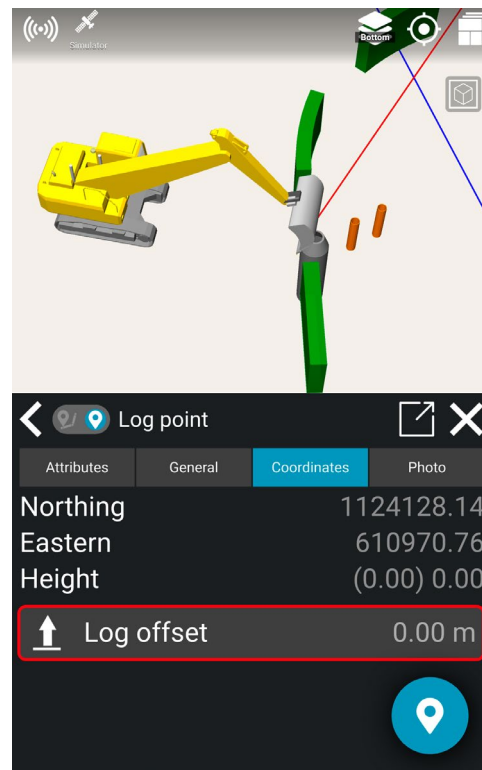
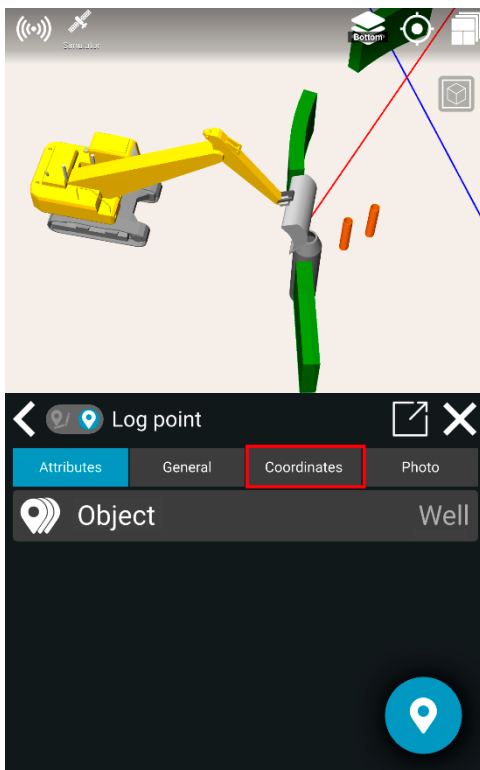

2) Enter the measurement for the offset.

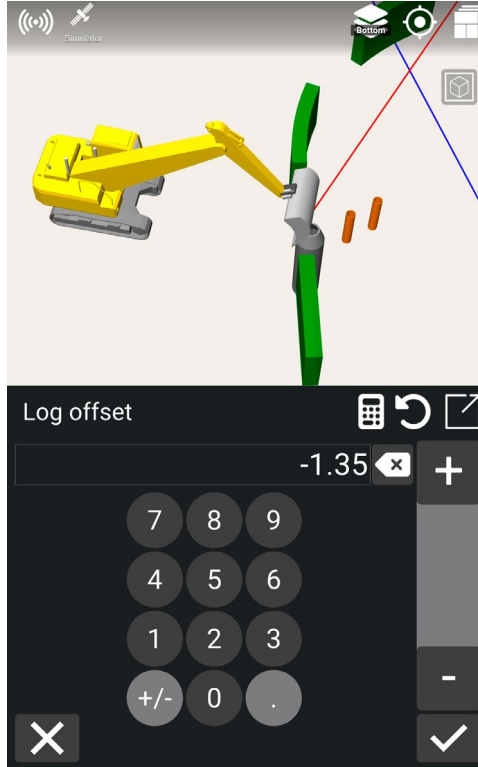

3) Click on the check mark.



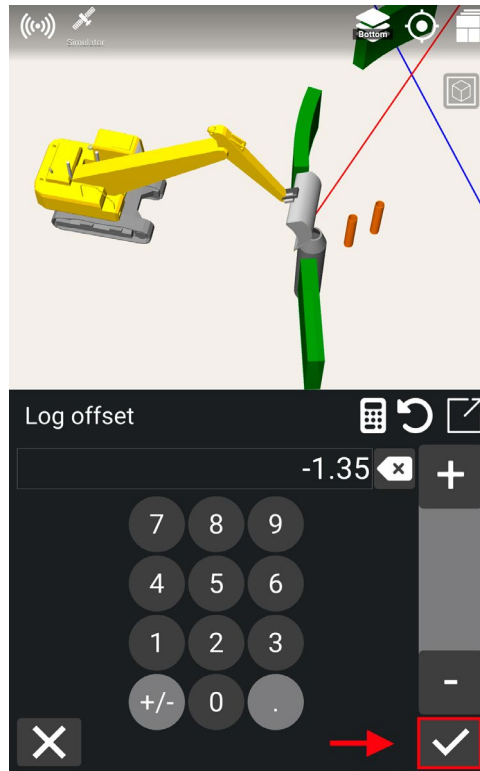

- 4) The result will show two numbers for the height, like this: **(0.00) -1.35**. The number in the parenthesis is the logged point's height, and the number after the parenthesis is the calculated height after applying the offset.
- 5) Click on the **log point icon** in the bottom right corner.

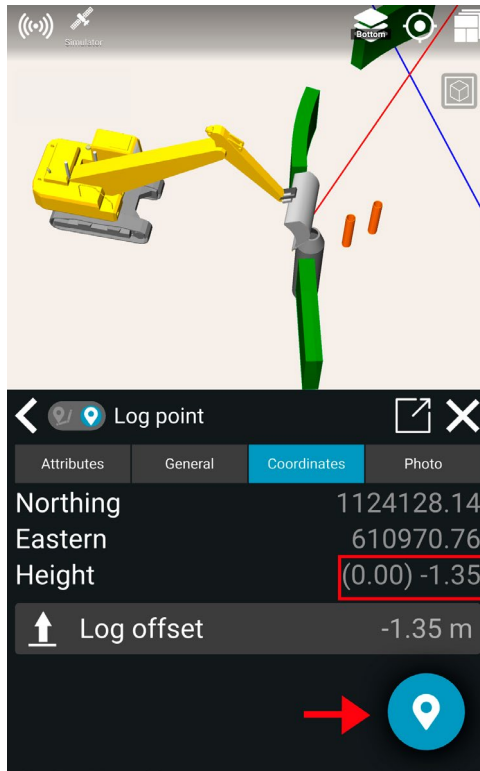

6) You have logged an offset for the point or line point:

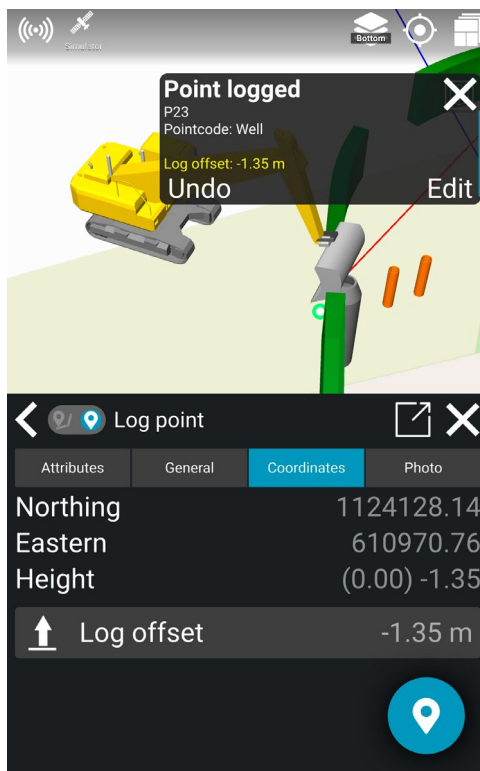

### 7.6.1. Edit a log offset

To edit a log offset for a point or a line point:

- 1) Go to **Project > References**
- 2) Click on the point or line point name.

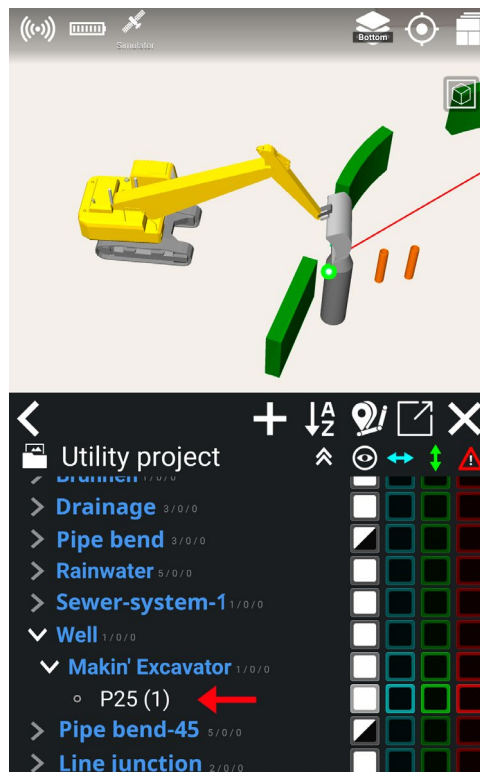

- 3) Click on the **pen tool** to edit.

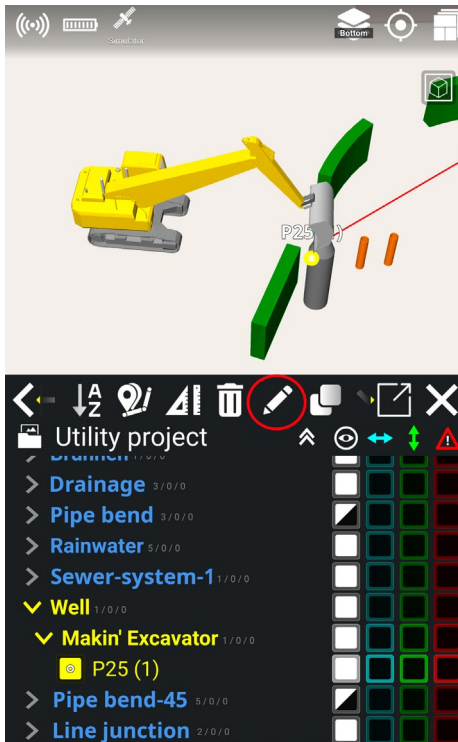

4) Go to 'Coordinates'.

5) Click 'Log offset'.

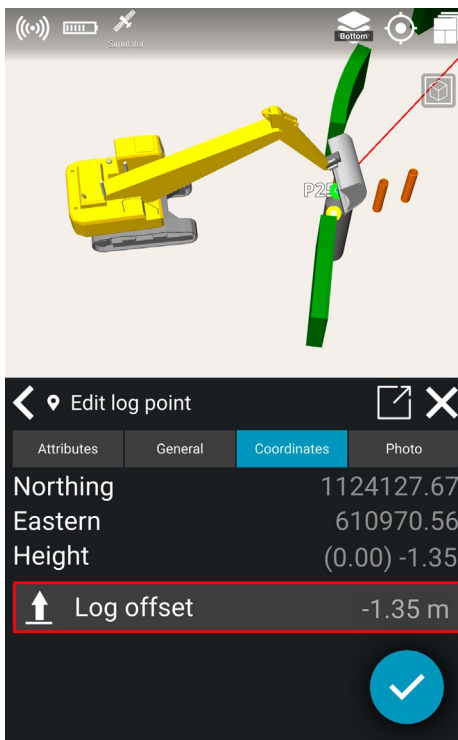

- 6) Set the offset and click on the check mark.
- 7) Click on the check mark in the bottom right corner.

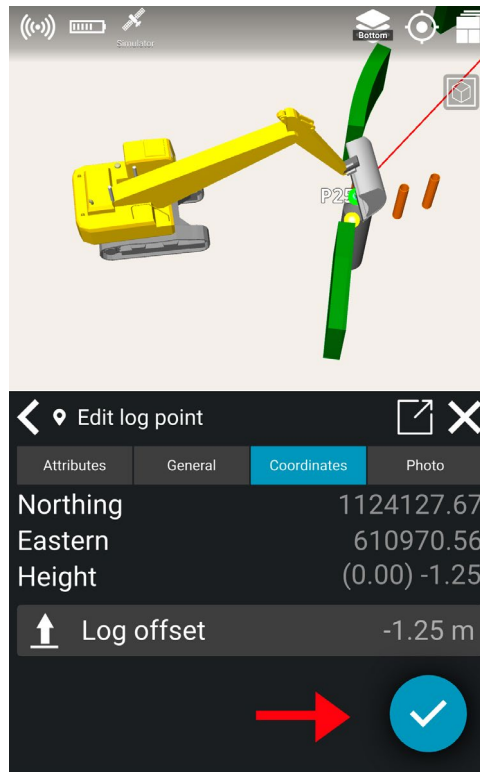

- 8) The offset is now edited.

## 7.7. Photo

You can add photos to the as-built documentation by taking photos of objects you want to call attention to and document.

- 1) Log a point or line point.
- 2) Edit the logged point or line point:
  - a) **Option A:** Click on **'Edit'** in the notification
  - b) **Option B:** Long-press the point on the work screen. Click on the **pen tool**.

- c) **Option C:** Click on the point's name in the reference dialog. Then, click on the **pen tool**.

- 3) Click on the tab **'Photo'**

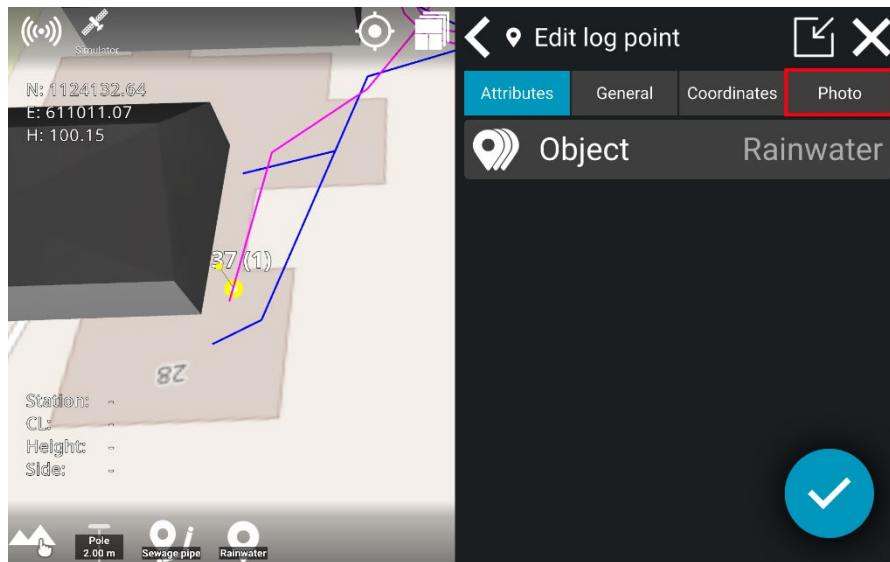

- 4) Click on the **camera** icon to take a photo of the desired object

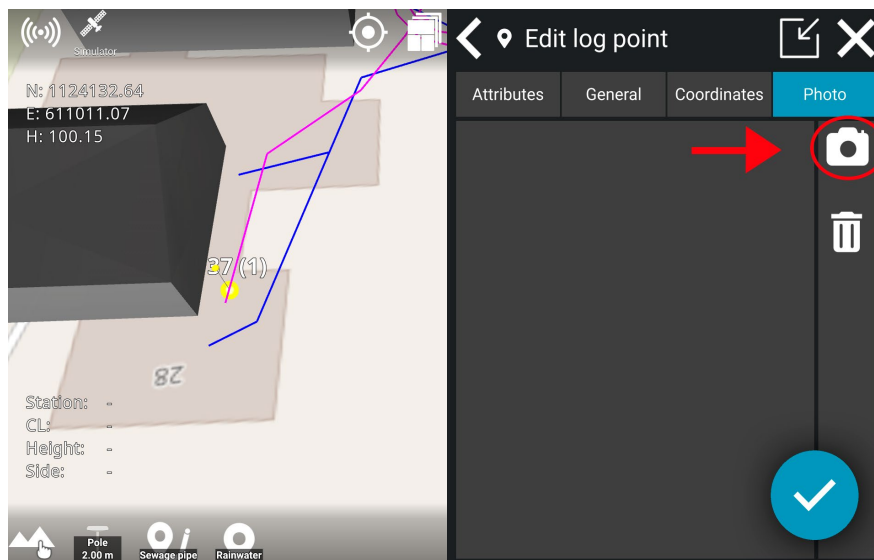

- 5) Take the photo by clicking on the **camera** icon.

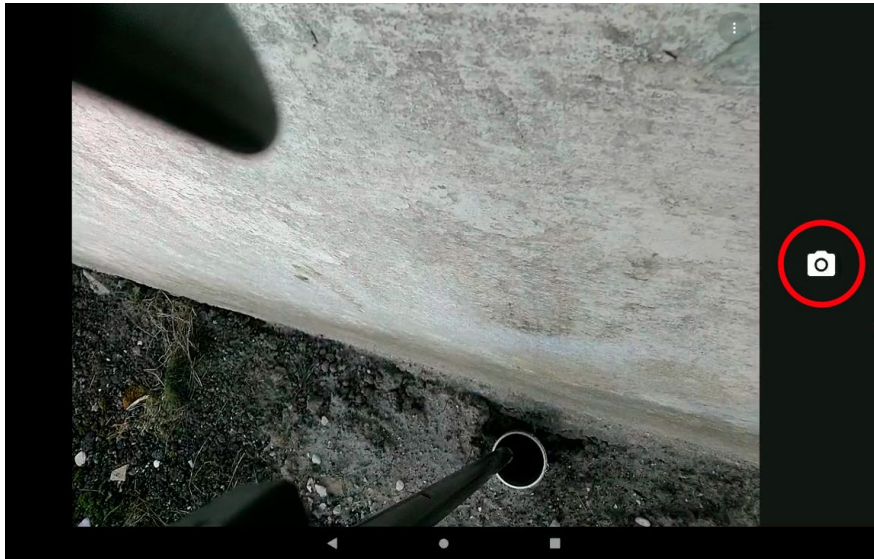

6) Click on the check mark.

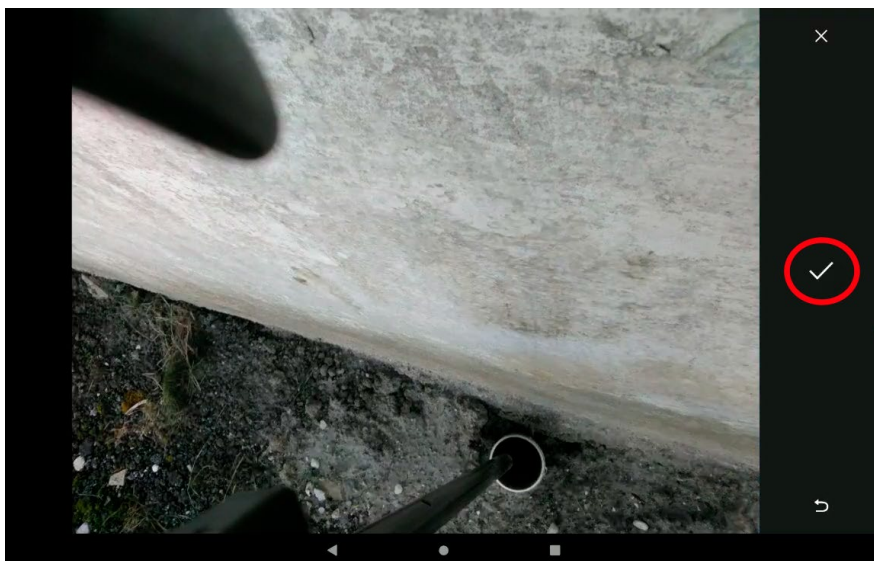

7) Click on the checkmark in the bottom right corner to confirm the editing.

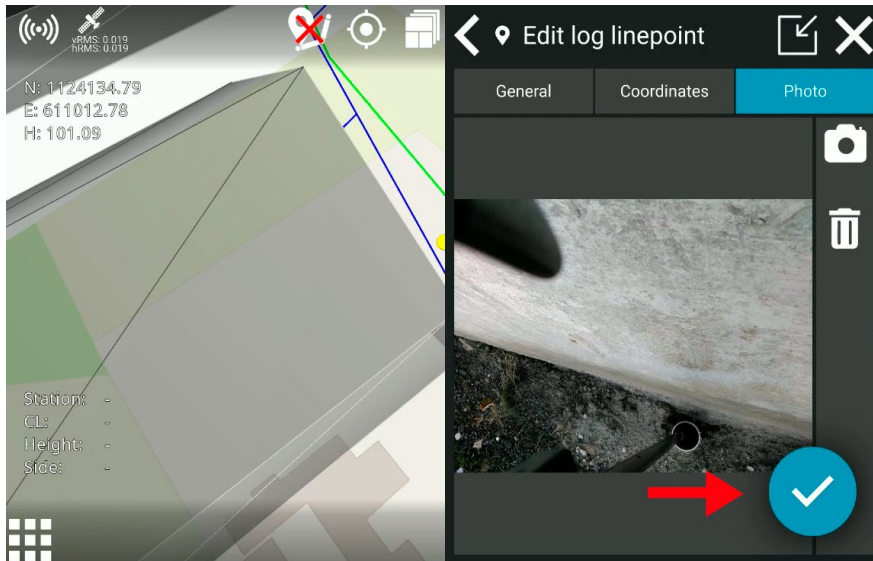

- 8) Your photo has now been saved as as-built data for the logged point.
- 9) The photos used for documentation can be downloaded as as-built data from Makin' Cloud.

## 7.8. Create objects and attributes on Makin' Cloud

You can create objects and attributes for a project on Makin' Cloud. Objects and attributes can be created in a specific project or set as default project files. Please note that if you create objects and attributes as default project files, they will be available in all new projects in the organization on Makin' Cloud.

### For a specific project:

Makin' Cloud > *Choose organization* > Projects > *Select project* > Attributes



MAKIN Organizations / Makin

Dashboard Projects Systems Users Licenses Transfer Suborganizations Settings

ENG - road project demo

Project Files **Attributes** As-built Settings

Add folder Download folder Show deleted files

files

Name	Size	Last modified	Actions
1 Road Models		5 months	
6 Yard		5 months	
Codes		5 months	
Driveway		5 months	
Project codes		5 months	
Vegetation		5 months	
2 Water	0 B	5 months	
CL-road.xml	13.2 KiB	5 months	
Ditch.xml	37.0 KiB	5 months	
Fixpoints.bt.xml	2.5 KiB	5 months	
Lines-Driveway4.xml	39.7 KiB	5 months	
Lines-driveway-2D.dxf	391.0 KiB	5 months	

### Default project files:

Makin' Cloud > Choose organization > Settings > Default project files > Attributes

MAKIN Organizations / Makin

Dashboard Projects Systems Users Licenses Transfer Suborganizations **Settings**

Settings

Manage settings for the organization

General Integrations BETA **Default project files**

Default project files

These files are automatically copied to newly created projects. Notice that only .txt og .json files are allowed.

Add folder **Attributes**

files

Name	Size	Last modified	Actions
Objects		7 months	
Project objects		6 months	
txt		22 days	

Drag files or click to select files (zip-files are automatically extracted)

### 7.8.1. How to create objects

- 1) Click on 'Edit' to begin creating a new object.

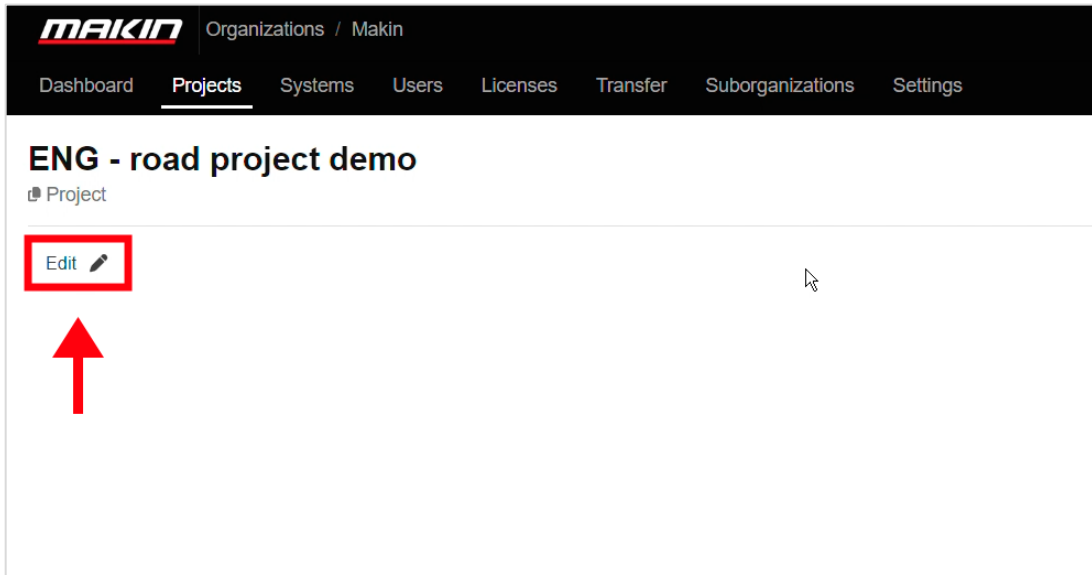

2) First you need to add and name the group, e.g. Sewage.

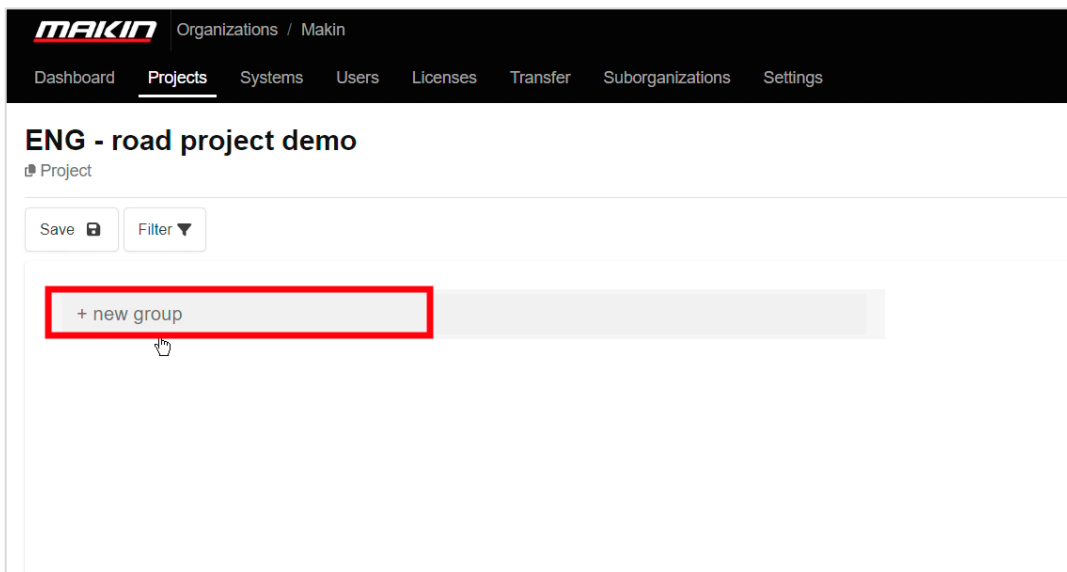

3) Add subgroups for more details. For example, if the group is 'Sewage', you can add a subgroup called 'Wastewater'.

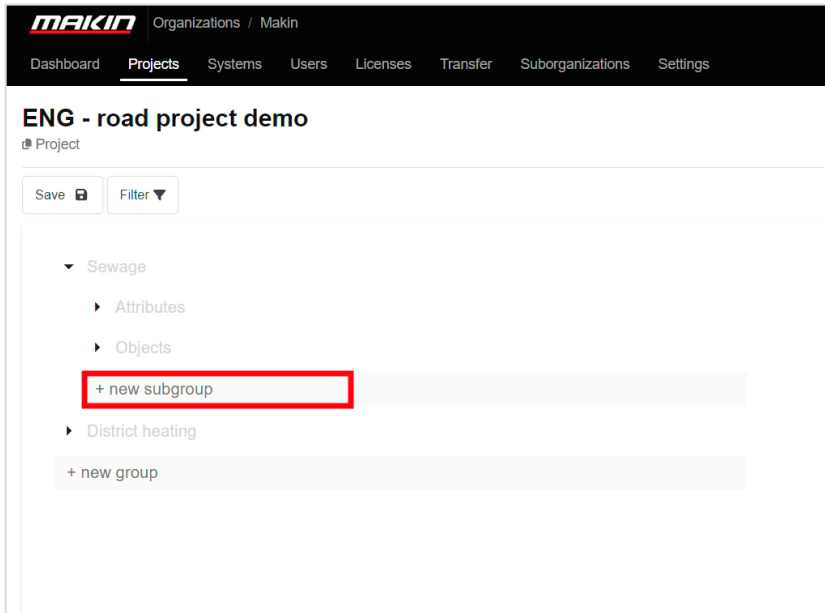

4) Add and name the object.

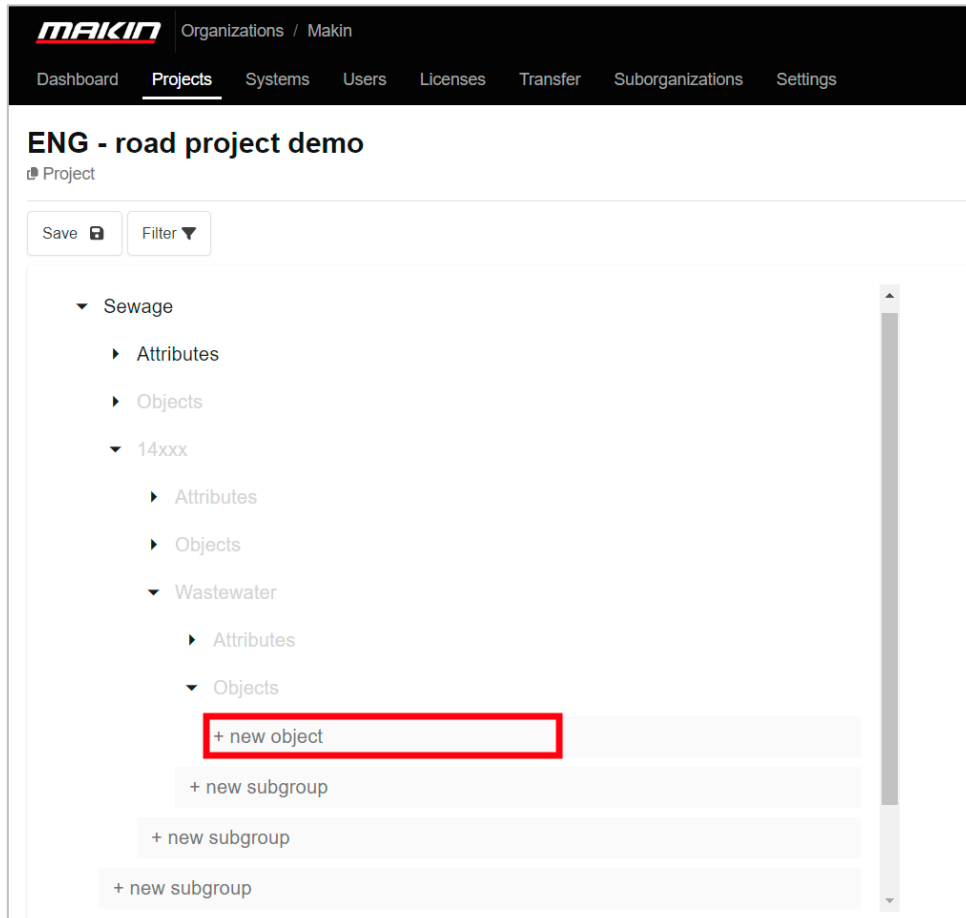

- 5) You can add an ID to the object and choose the relevant applications and geotypes where the object can be used. Click on the icons to select or deselect. Icons will grey out when deselected.



The screenshot shows a configuration form for an object. It has the following fields and options:

- id**: A text input field containing the value "4000".
- name**: A text input field containing the value "Main supply line".
- apps**: A row of five icons representing different applications. The first icon (a location pin) is active, while the others are greyed out.
- geotype**: A row of three icons representing different geotypes. The first icon (a circle) is active, while the others are greyed out.

- 6) Add more objects if needed.

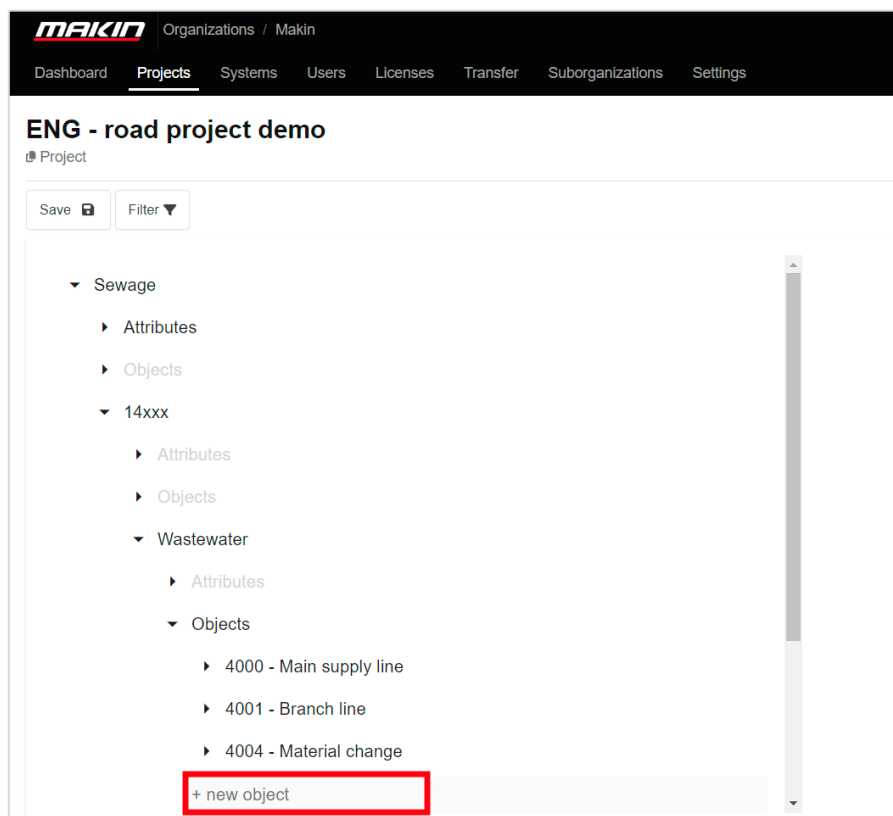

The screenshot shows the MAKIN web interface. The top navigation bar includes "MAKIN Organizations / Makin" and a menu with "Dashboard", "Projects", "Systems", "Users", "Licenses", "Transfer", "Suborganizations", and "Settings". The main content area is titled "ENG - road project demo" and shows a tree view of project objects. The tree structure is as follows:

- Project
  - Sewage
    - Attributes
    - Objects
  - 14xxx
    - Attributes
    - Objects
  - Wastewater
    - Attributes
    - Objects
      - 4000 - Main supply line
      - 4001 - Branch line
      - 4004 - Material change
      - + new object** (highlighted with a red box)

- 7) Click **'Save'** to save your changes.

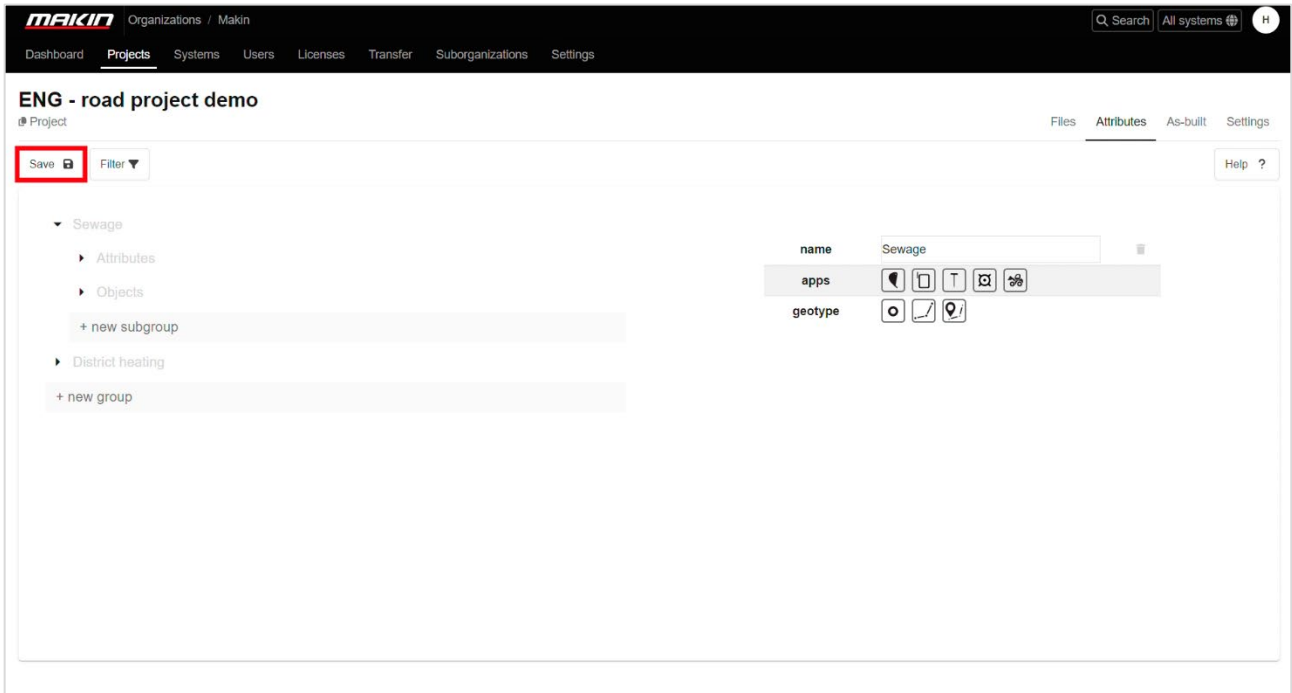

## 7.8.2. How to create attributes

- 1) Click on 'Edit'.
- 2) Add and name the attribute.

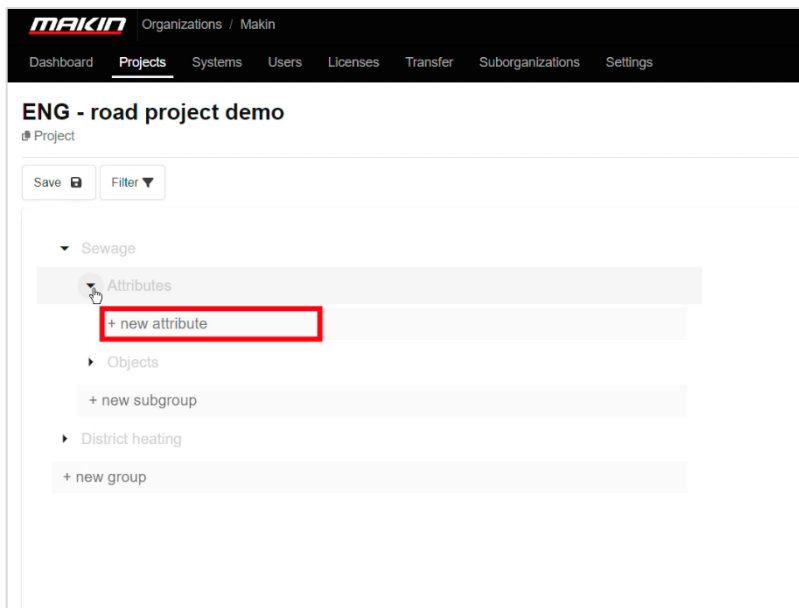

- 3) You can choose which applications and geotypes you want the attributes.

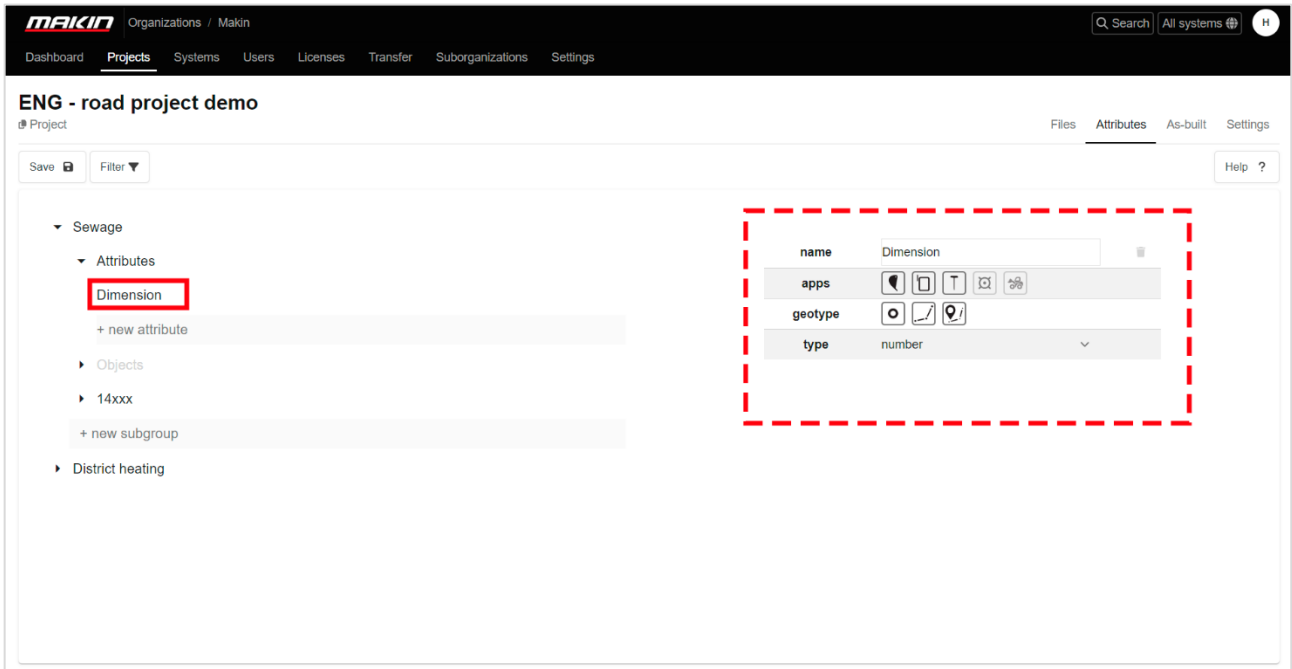

4) You can also add further information in the form of number, text, or list under 'Type'. The chosen type decides how the user of the application can add details to the attribute:

- a. **Number:** The user can enter a number on the tablet.
- b. **Text:** The user can write a text to the attribute.
- c. **List:** The user can choose between the options created on Makin' Cloud.

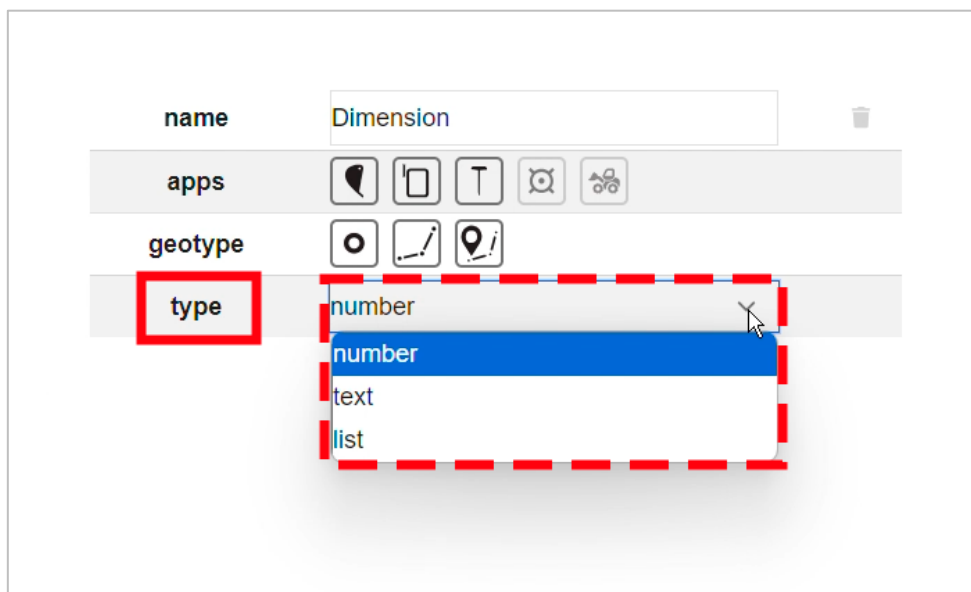

- i. If you choose 'List', you can write the options for the list. Click on 'Option' to add an option to the list:

The screenshot shows a configuration panel for a 'Dimension' list. The 'name' field contains 'Dimension'. Below it are sections for 'apps' (with icons for location, mobile, text, camera, and share) and 'geotype' (with icons for point, line, and area). The 'type' is set to 'list'. There are two options: 'option 1' with the value 'ø100' and 'option 2' which is currently empty. A red box highlights the 'Options +' button, and a red arrow points to it from below.

- ii. Name the option. Click on 'Option' to add more options.

The screenshot shows the same configuration panel as above, but now with three options. 'option 1' has the value 'ø100', 'option 2' has the value 'ø110', and 'option 3' has the value 'ø160'. A red box highlights the 'option 3' input field. The 'Options +' button is now a simple button without a red box.

5) Add and name more attributes if relevant.

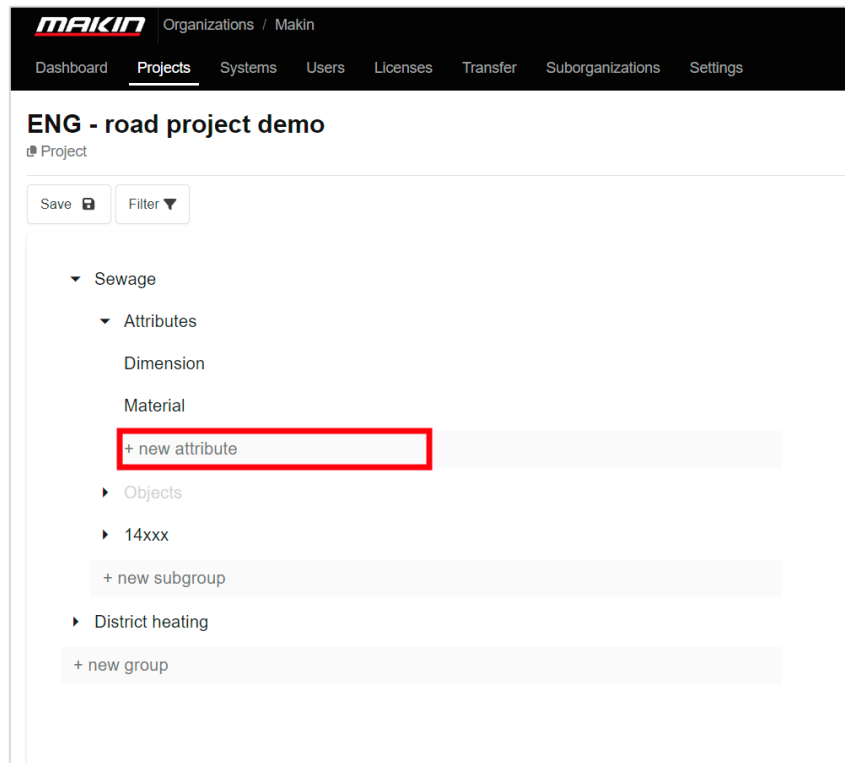

6) Click on 'Save' to save your work.

When you have saved the work, the objects and attributes will automatically be synchronized from Makin' Cloud to the project on the tablet.

The attributes and objects you have created can be selected by long-holding the **log button** or tapping 'Logging' in the main menu in the Makin' 3D app.

### 7.8.3. Filter for overview

The 'Filter' function allows you to search and see which attributes and objects are added for specific applications or geotypes.

1) Click on 'Filter'.



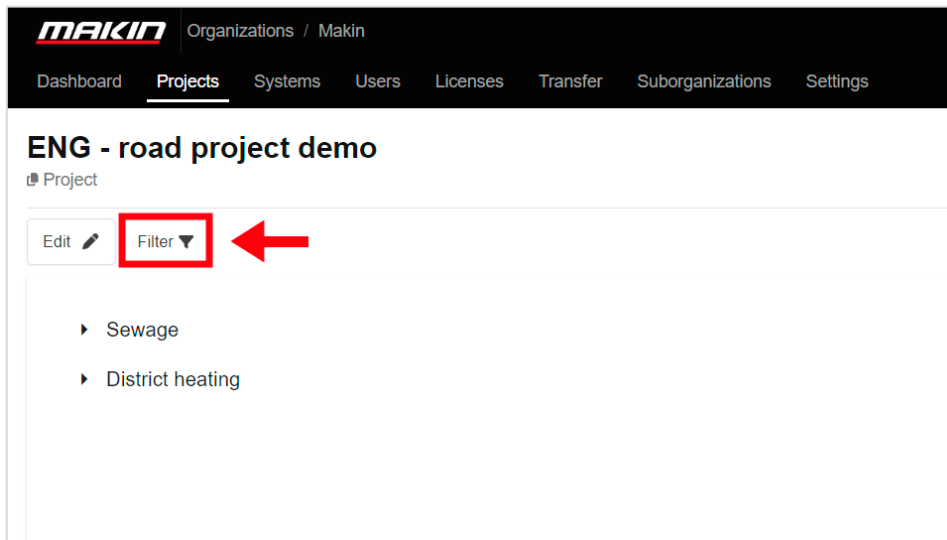

2) Select the applications and/or geotypes you want to filter.

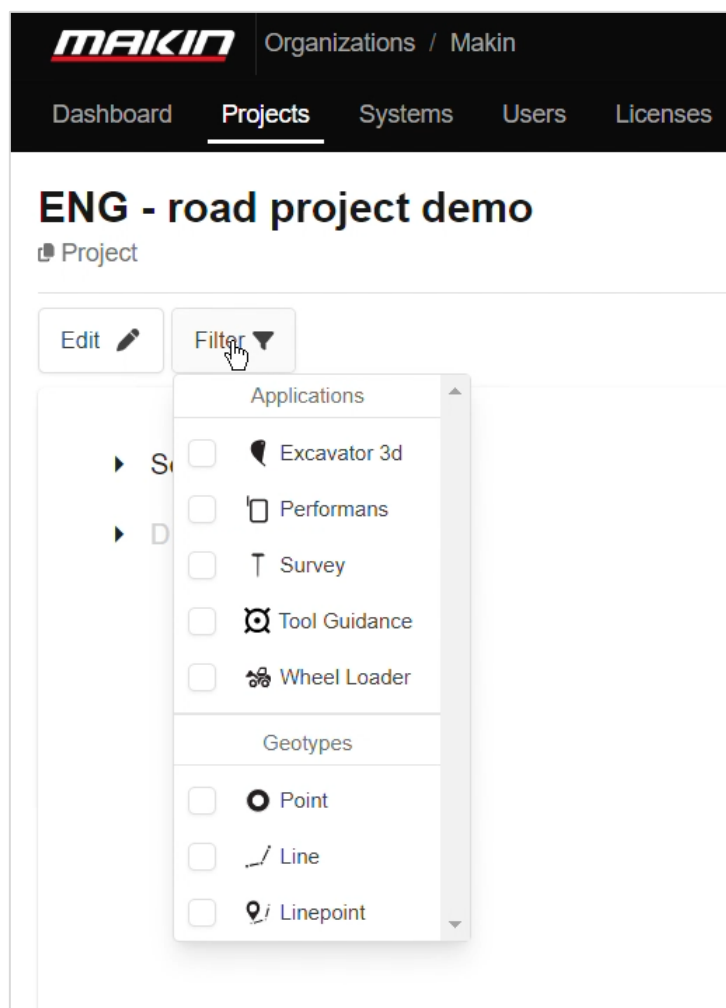

- 3) If an attribute or object is not added for a specific application or geotype, a red eye icon will show that it is not visible for that application or geotype.

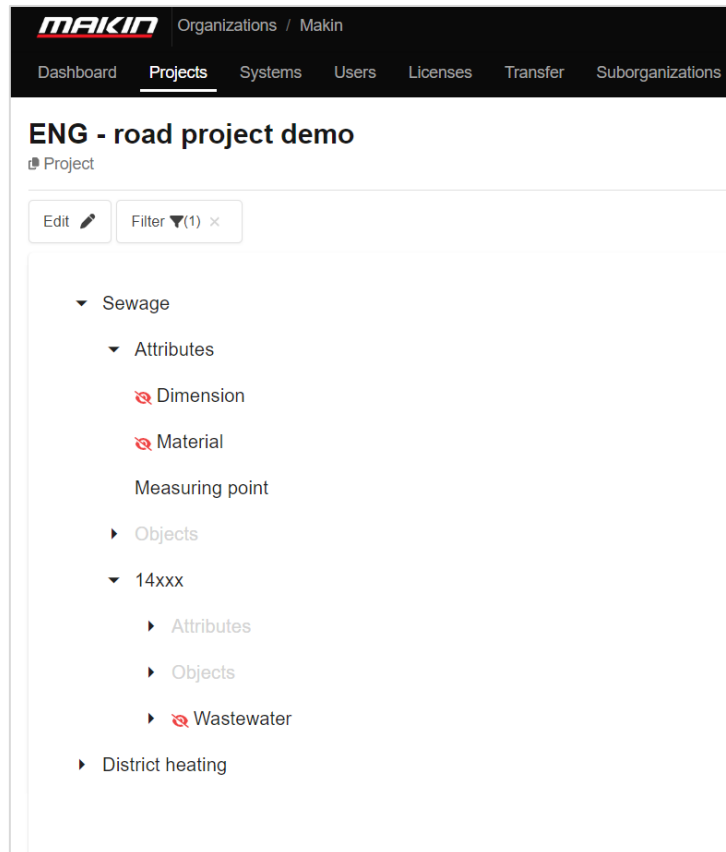

## 7.9. Object information and attributes

When a point is logged, several different pieces of information are logged together with the object and coordinates. Below, you can see a list of information with an explanation of the different values.

<b>P</b> : Point name: A unique name used to identify individual points	<b>N</b> : The measured points northern coordinate. This value is measured on the tool point
<b>E</b> : The measured points' eastern coordinate. This value is measured on the tool point	<b>H</b> : The measured points elevation. This value is measured on the tool point

<b>VRMS:</b> Shows the vertical accuracy of the GNSS when the point was logged. Accuracy is defined on the GNSS antenna, not the tool point	<b>HRMS:</b> Shows the horizontal accuracy of the GNSS when the point was logged. Accuracy is defined on the GNSS antenna, not the tool point
<b>Mount point:</b> Shows which mount point was chosen for the connected NTRIP server	<b>Project offset:</b> If an application has a project offset entered to adjust tool point elevation to match the elevation of a known point on the construction site.
<b>ExtSurf:</b> Showing if the point measured is done on an extended surface value can be 0(no) or 1(Yes)	<b>ToolHeight:</b> Shows the height offset applied to the measured tool point, e.g. Pole height for Makin' Survey, or Tablet height for Makin' PerFormans
<b>Time:</b> The time where the point was logged logged in a YYYY-mm-dd HH:MM:ss format Example: 2022-02-15 09:43:34	<b>SystemName:</b> Shows the name of the system that logged the point. This system name matches the system name on the Cloud
<b>PDOP:</b> Dilution Of Precision, indicates how errors in measurement will affect the absolute position calculation. Dop can be calculated in different variants. (HDOP, VDOP, PDOP, TDOP, GDOP) The DOP value logged in the as-built data is the PDOP value. (Position dilution of precision) This can be considered as the 3D DOP. The value is relative and not related to a specific measurement unit.	<b>Sats:</b> Showing how many satellites were visible when the point was logged. The value is the sum of satellites, and not divided into specific satellite constellations (GPS, Glonass, Beidou, Galileo)
<b>LogOffset:</b> Delta height. Shows if the operator has added an offset to the logged point. Often used if it is impossible to log the exact position due to limited space. E.g., logging the inlet in a manhole. Then the operator can log a point on the top of the manhole, measure the distance from the measured point to the inlet, and enter this as a delta height.measured. Value shows accuracy in meters	<b>SiderefFile:</b> Side reference file. Shows the name of the file used as active side reference when point was logged
<b>App:</b> Shows which system has logged this specific point.	<b>SiderefName:</b> Side reference name. Shows the name of the specific reference inside the reference file, used as an active side reference when a point was logged.
<b>HeightOffset:</b> If the operator has entered an offset, the value is documented in this field. This offset will have a direct effect on the Href value.	<b>Sidedist:</b> Shows the horizontal distance from the tool point to the side reference when the point was logged.

<p><b>POI:</b> This is set if the operator has marked a point as a <b>Point Of Interest</b>. The value can be 0 (no) or 1 (yes).</p>	<p><b>HeightrefFile:</b> Height reference file. Shows the name of the file used as the active height reference when the point was logged.</p>
<p><b>ToolPoint:</b> Shows which tool point was used to log the point. Only relevant for Excavators that can switch and log with Left, Center and Right tool point on the bucket.</p>	<p><b>HeightrefName:</b> Height reference name. Shows the name of the specific reference inside the reference file, used as the active height reference when the point was logged.</p>
<p><b>Height:</b> Shows the vertical distance from the tool point to the height reference when the point was logged.</p>	<p><b>Comment:</b> If the operator has written a comment for the point, it will be shown here.</p>

## 7.10. Sort as-built data

Inside the reference menu, it is possible to enable sorting of the project's as-built data. Press the AZ button to open the sorting dialog.



In this dialog, you can choose which criteria you want to sort by. Press the button to activate or deactivate the criteria. You can also change the order you want to sort by. This is done by pressing and holding on a criterion and then moving it up or down the list.

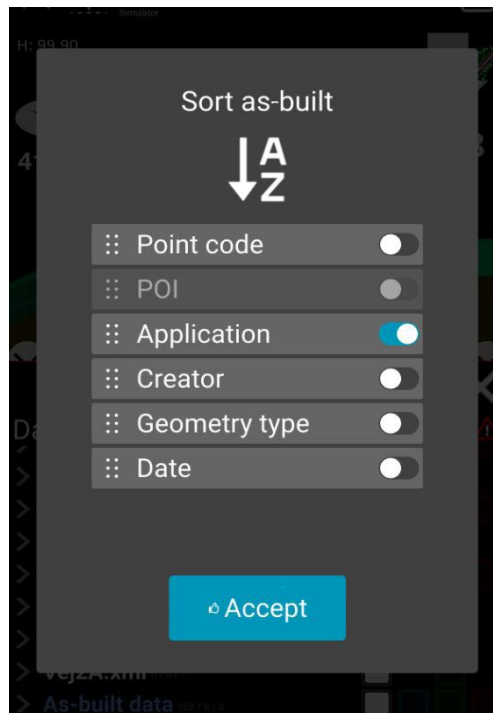

# 8. 2D functionalities

Menu > 2D functionalities

This menu option is only available when GNSS is disabled. See Chapter 9, [GNSS](#).

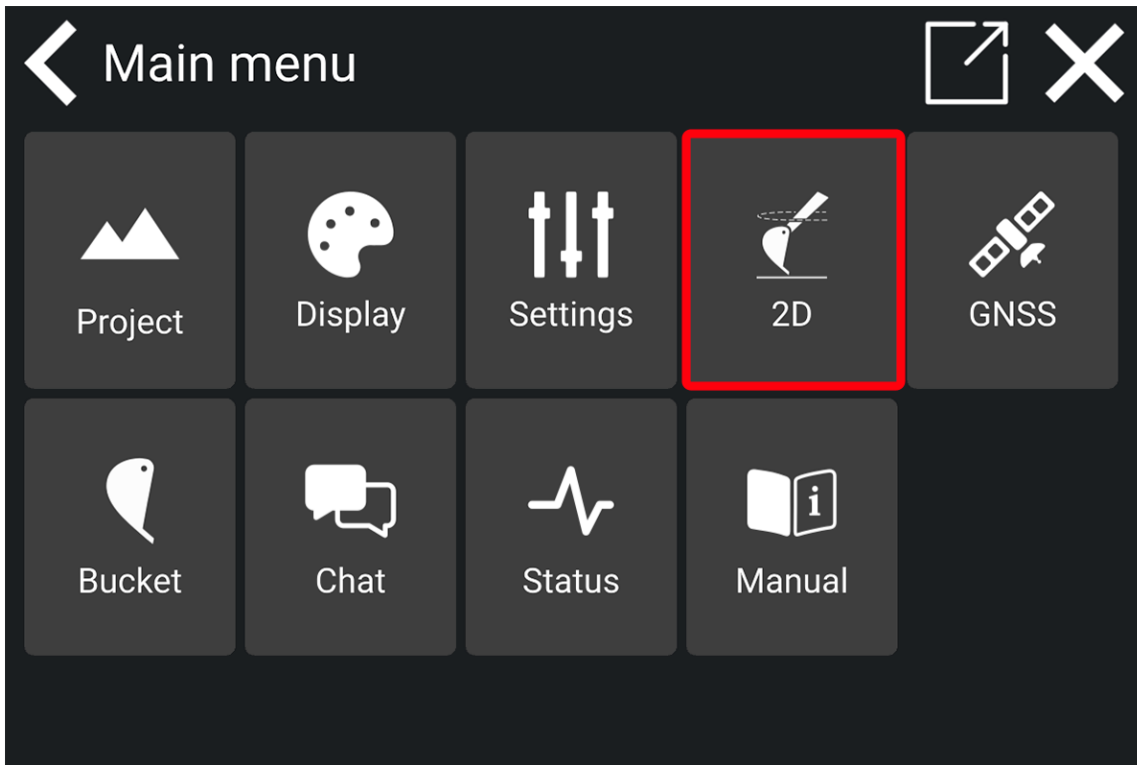

## 8.1. Main direction

Menu > Project > Plane > Main direction

Press the screen, select **Main Direction** in the menu, and you will set the direction of your work.

- The Blue triangle will now indicate your **Main slope** - direction
- The Red triangle will indicate the **Side slope** - direction
- The clear triangle on the compass ring will show you the current direction of the machine.

When the direction of the machine is on top of the Blue triangle, you will be on the **Main slope** - direction.

- **N** indicates the true North direction

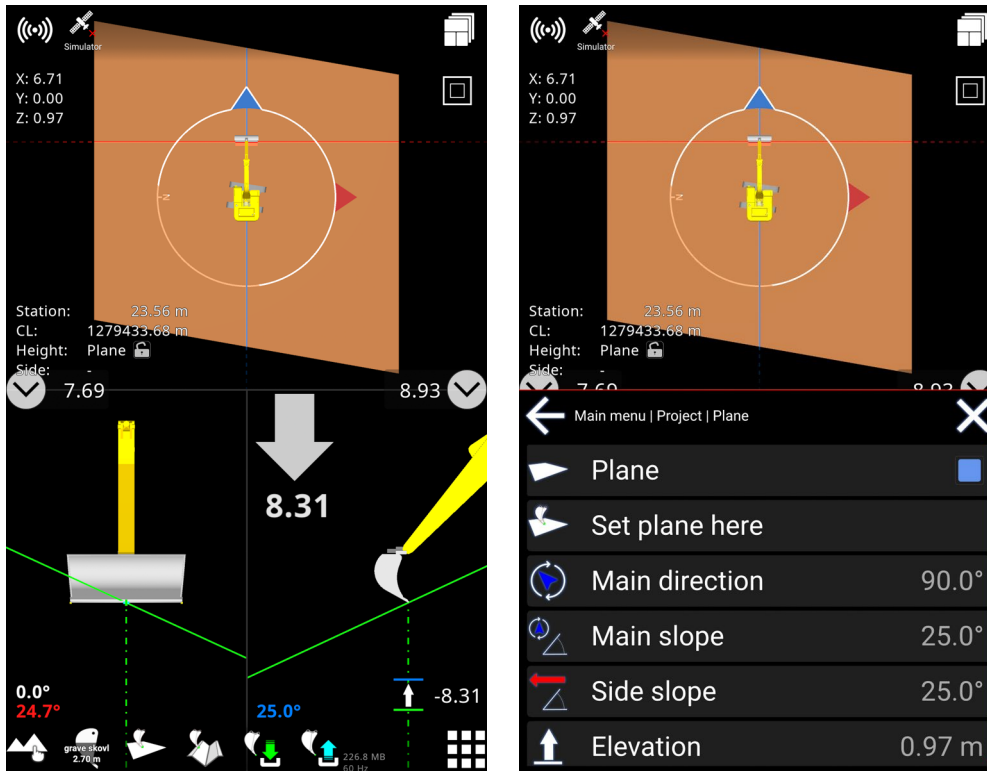

## 8.2. Store position

Menu > 2D > Store position

This feature is also available directly from the quick keys when 'GNSS device' is disabled under GNSS. See Chapter 9, [GNSS](#).

Save the excavator's current position. The coordinates of the machine will be stored - not just the height, which will make it possible to move the machine to another location in a 2D environment and later continue work from a new location.

An example of how to use this feature is described in the paragraph '**Pickup position**' below.

## 8.3. Pickup position

Menu > 2D > Pickup position

This feature is also available directly from the quick keys when 'GNSS device' is disabled under GNSS. See Chapter 9, [GNSS](#).

This feature is used to position the machine at the desired coordinate determined by the machine's tool. The default value given is the latest saved position by the 'Store position' feature described above, but you may specify any coordinate.

#### **An example of use:**

- 1) Select the tool point for one of the corners of the bucket that you wish to use to save the location with. You do this by tapping the bucket and then tapping on the corresponding corner of the bucket.
- 2) Position the corner of your bucket on an identifiable point, like a control point - or similar marking.
- 3) Tap '**Store position**' to save the position. The position will only be available in the system's memory and is not to be seen.
- 4) Now you can move the machine anywhere to do some temporary work.
- 5) When you want to continue working from your stored position, simply go back to your stored position by following steps 1 and 2 above, and this time choose '**Pickup position**'.

## **8.4. Laser height**

### **Menu > 2D > Laser height**

Enter the height of a nearby construction laser. When the laser beam hits the laser stick sensor, the system can use its height as a reference for the machine.

## **8.5. Auto laser height**

### **Menu > 2D > Auto laser height**

Enabling 'Auto laser height' will automatically grab a laser beam from a nearby construction laser when hitting the machine's laser stick sensor. This will position the machine at the height given by the 'Laser height' value - described above.



## 9. GNSS

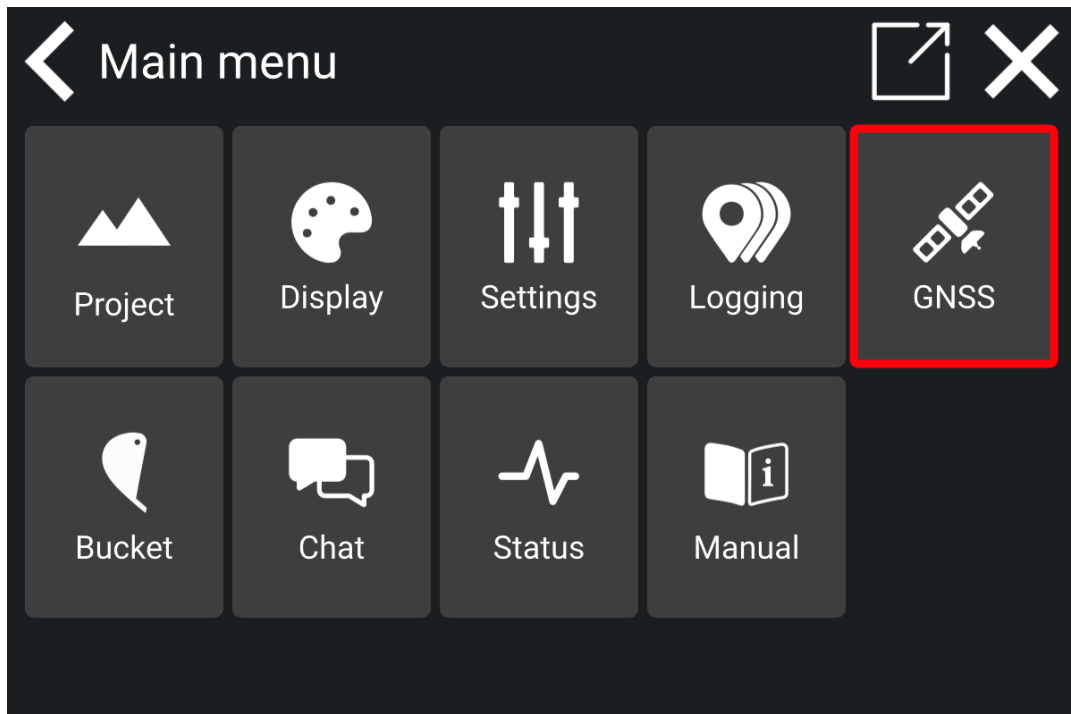

### 9.1. Correction source

In the 'GNSS' menu, you can choose whether you want to run with the GPS receiver towards **NTRIP** (CPOS, Smartnet, TopNet) or **UHF** (radio) towards a local base station. If you choose UHF, you must select the frequency and ID that allow Makin' 3D to communicate with the base you want.

**How to choose and create a correction source:**

- 1) Go to **GNSS > Correction source**

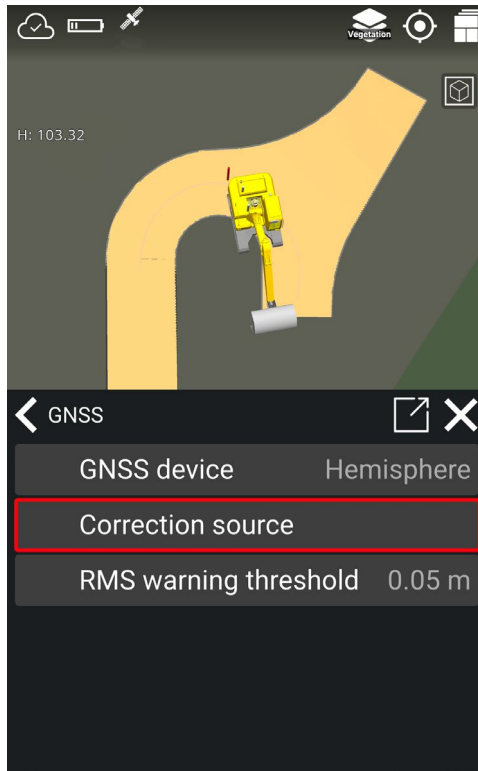

- 2) In the correction source dialog, you can activate and deactivate NTRIP and UHF profiles. You can also create or edit a correction profile.

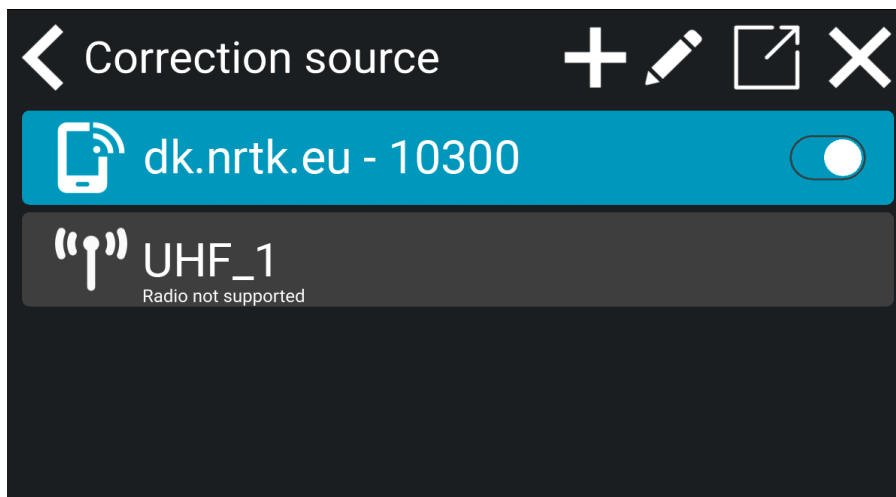

- 3) To create a correction profile, tap on the **+** symbol. Edit a correction profile by tapping on the **pen tool**.

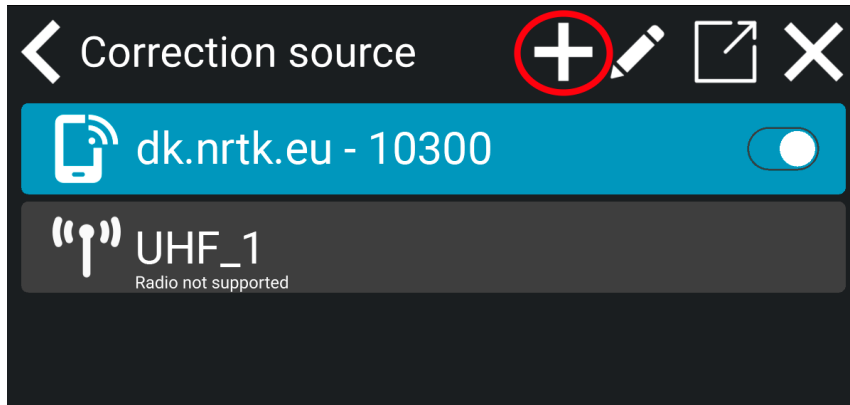

- 4) When tapping on the + symbol you can choose between creating a NTRIP or UHF profile. See the paragraphs below for more information about UHF and NTRIP.

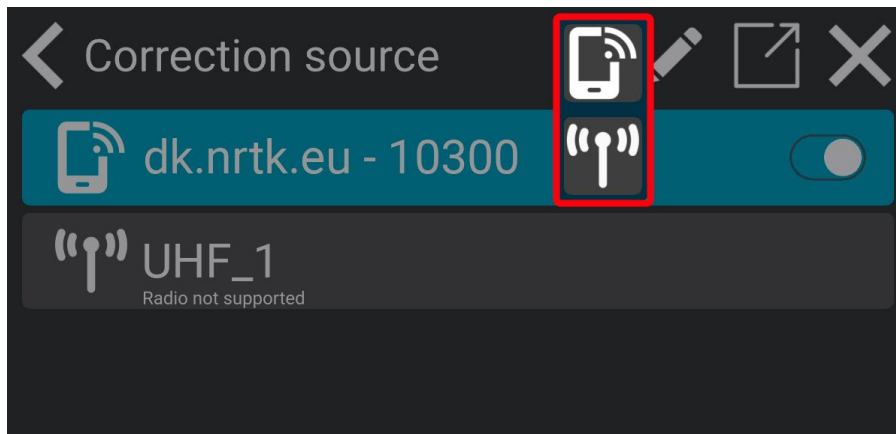

### 9.1.1 Radio

Under '**Correction source**' you see the current type of correction source being used.

- Choose 'UHF' if you use a radio to connect to the correction signal.

#### How to create a new UHF profile:

- 1) You can create a new UHF profile by tapping on + symbol and then the **UHF icon**.

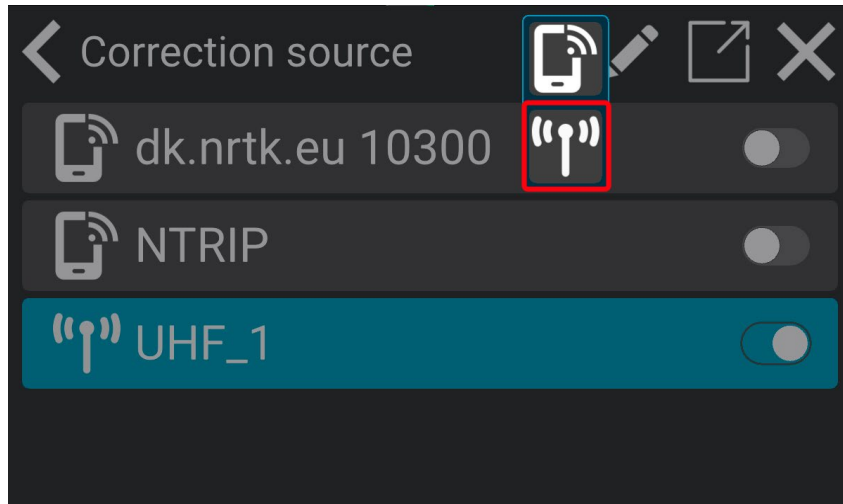

2) To set up the UHF profile, the following details must be entered:

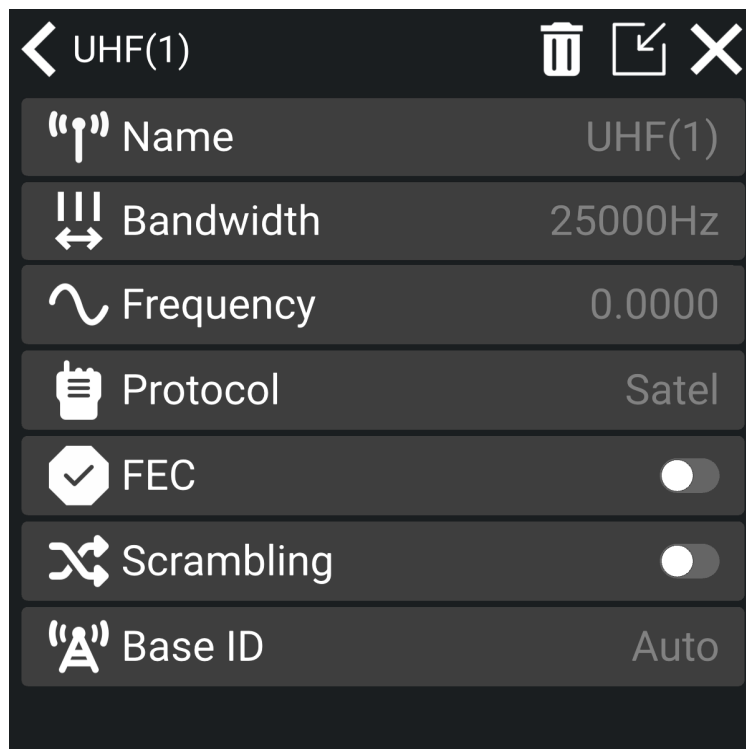

- **Name:** Name the UHF correction profile.
- **Bandwidth:** Select either 25000Hz or 12500Hz.
- **Frequency:** Tap 'Frequency' to set the frequency of the base station.
- **Protocol:** Choose the protocol you want to use.

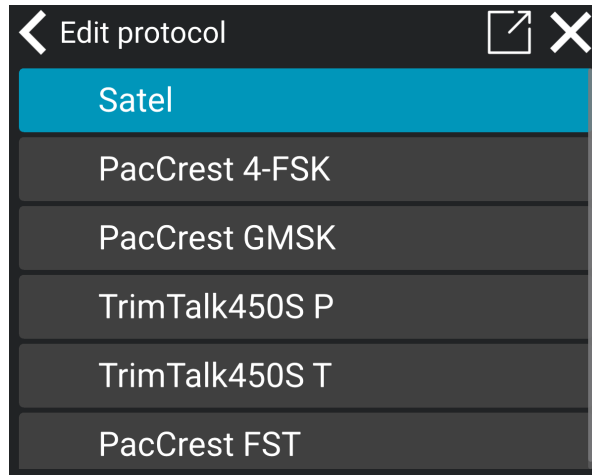

- **FEC:** Tap the button to activate or deactivate the FEC.
- **Scrambling:** Tap the button to activate or deactivate the scrambling.
- **Base ID:** Tap 'Base ID' and choose 'Auto' to automatically jump between base stations with the same frequency or choose an ID of a specific base station to lock on to it by tapping on 'Custom'.

*Please note,* that if you use the 'Auto' option, you might experience corrections from two bases, which is not optimal.

- 1) Choose between 'Auto' or 'Custom' to set the **Base ID**.

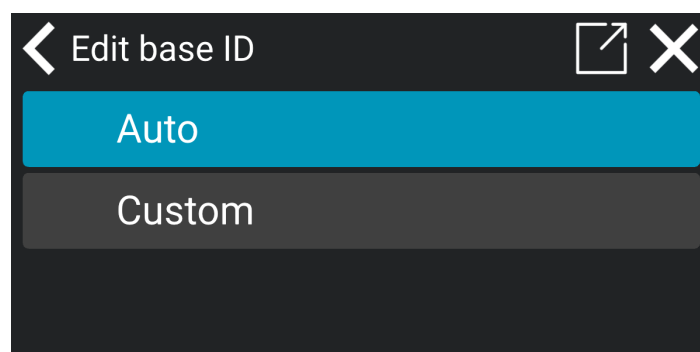

- 2) Tap on '**Custom**' to choose an ID of a specific base station.

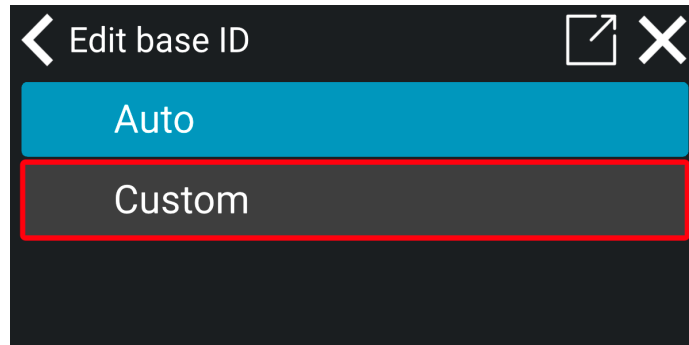

- 3) Set the ID of the specific base station you want to lock on to. Tap on the check mark to save.

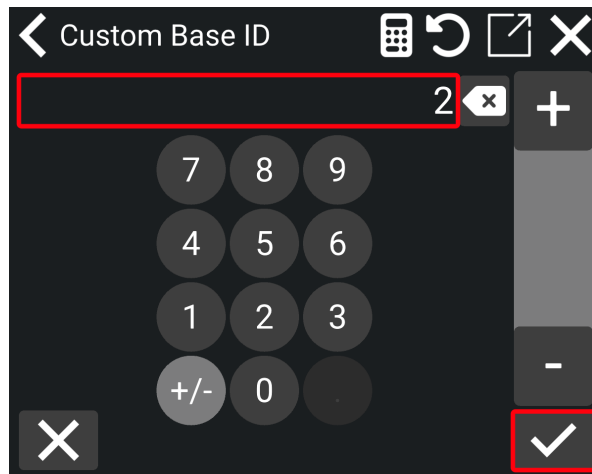

When you have created a UHF correction profile, you can activate the correction source you want to use. The current correction source will automatically deactivate.

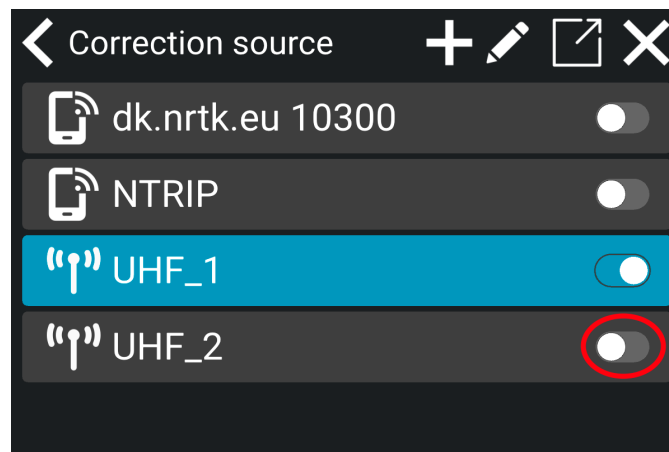

### 9.1.2. NTRIP

Makin is able to use corrections from several NTRIP providers. Depending on the installed GNSS receiver, the information must be entered by the Makin' supporter or installer in the Makin' application's GNSS menu. Makin needs some NTRIP server details to be able to connect to the server and receive useful corrections. These details will be delivered from the selected NTRIP provider when subscribing to an account.

- 1) You can create a new NTRIP profile by tapping on the '+' symbol and then the **NTRIP icon**.

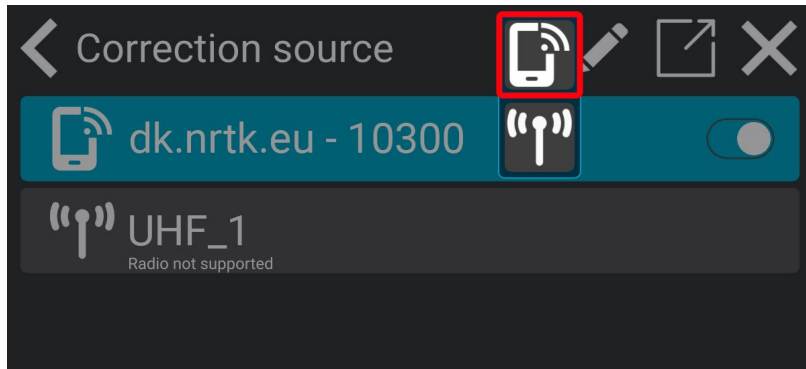

- 2) To connect to the NTRIP network and receive corrections, the following details must be entered:

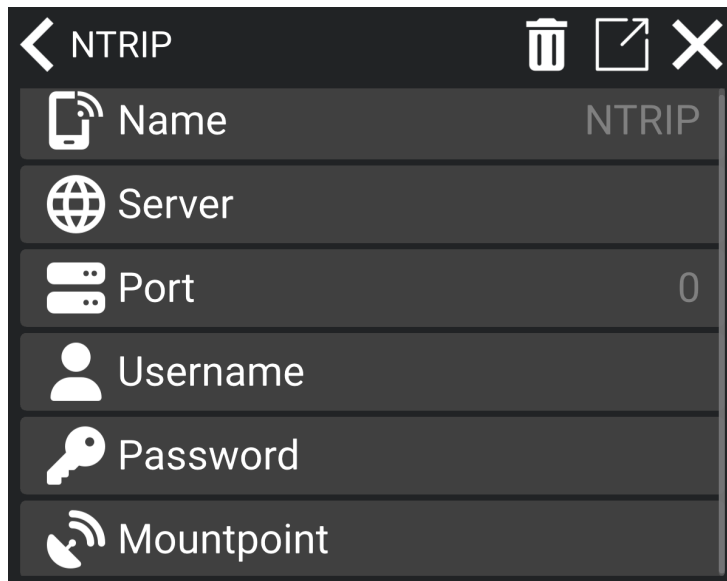

- **NTRIP name:** Name the NTRIP correction profile.
- **NTRIP server:** The web address where the server can be accessed.
- **NTRIP port:** This is usually a 4-digit number from where Makin must receive the corrections.
- **NTRIP username:** Every Ntrip account on the server has a unique username that Makin needs to log in to the server.
- **NTRIP password:** Every Ntrip account on the server has a unique password that Makin needs to log in to the server.
- **NTRIP mountpoint:** This mountpoint defines which corrections and from which GNSS satellites Makin can calculate an accurate position.

Please note that the **mountpoint** is custom. You need to fill in the details for the mountpoint.

- 1) Tap on '**Mountpoint**'

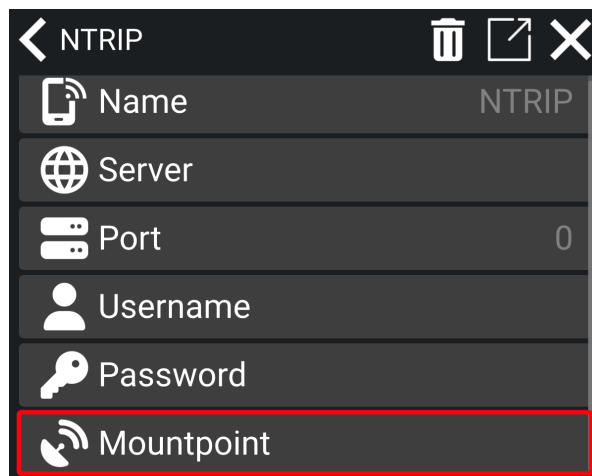

- 2) Tap on '**Custom**'

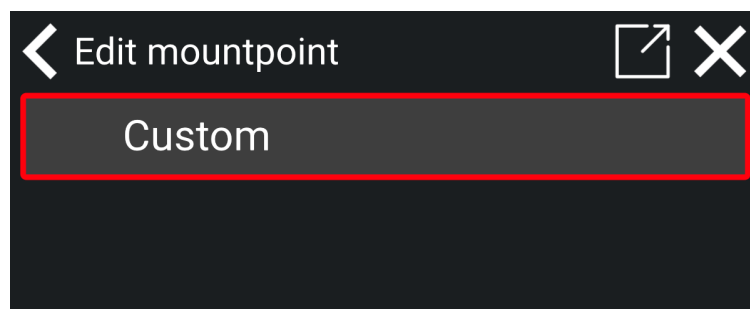



3) Enter the mountpoint name. Tap on the check mark to save.

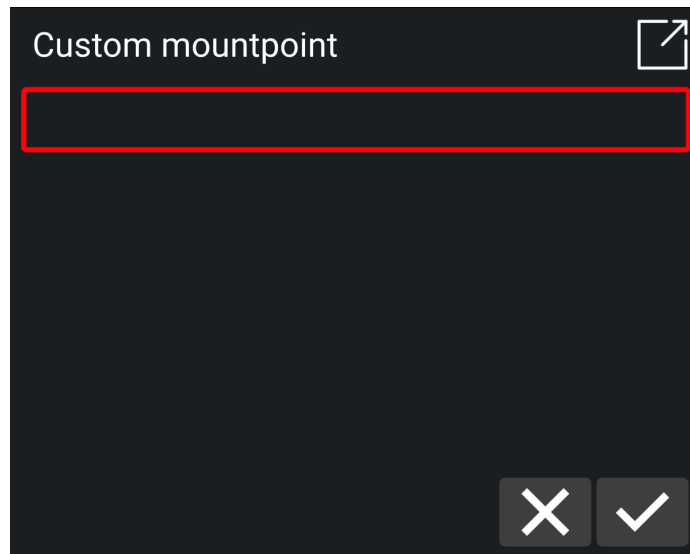

When you have created a NTRIP correction profile, you can activate the correction source you want to use. The current correction source will automatically deactivate.

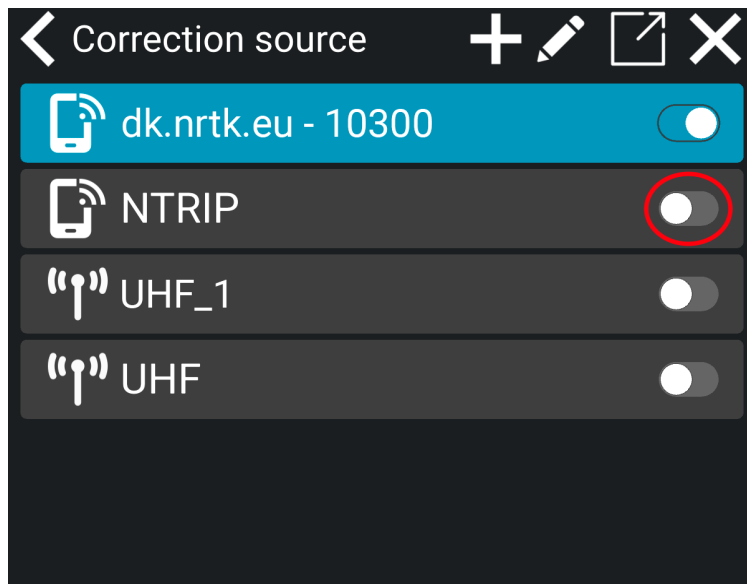

# 10. Bucket

## Menu > Bucket

There is a shortcut to this menu from the quick keys.

You will see all the buckets saved on the tablet. Tap the bucket you want to use, and always ensure that the calibration is correct before starting work.

For calibration: see Chapter 13, ***Calibration***.

To check your calibration, see Chapter 13.3., ***Check the calibration of your excavator***.

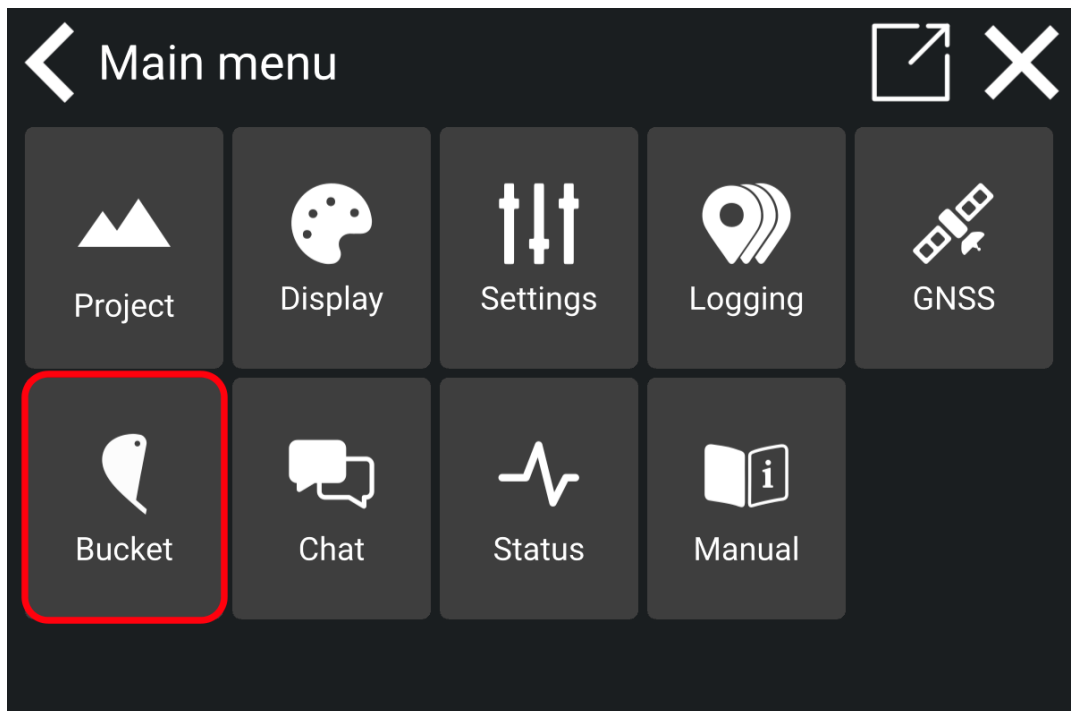

# 11. Chat

Menu > Chat

The chat feature helps you communicate with your colleagues about the project you are working on.

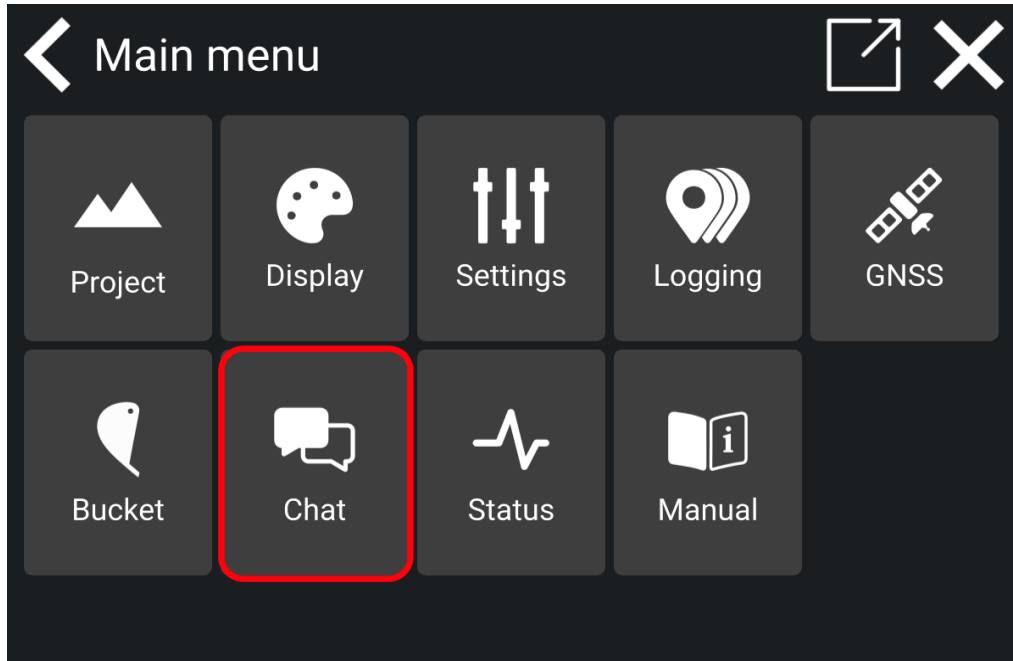

- You will see all office personnel and coworkers from your company or project. This depends on the structure created by your management.
- Tap a contact from the list to begin messaging.

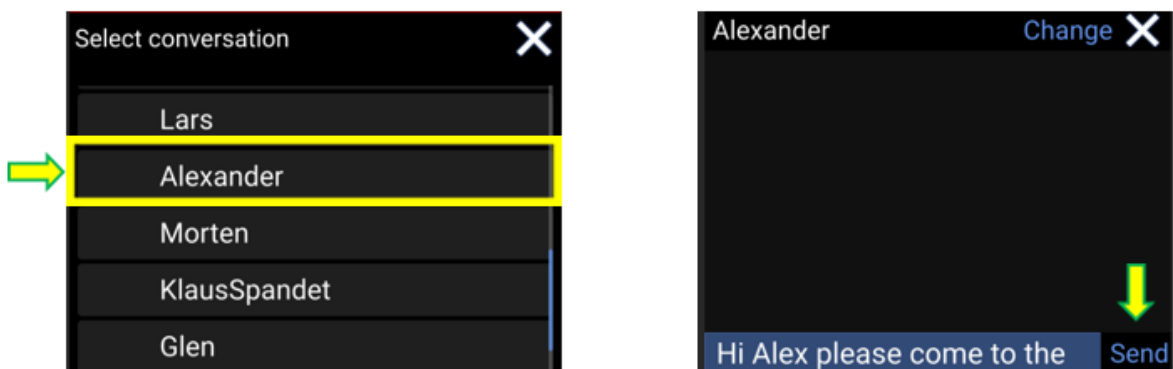

- Write a message and tap 'Send'.

# 12. Status

Menu > Status

This is where you will find various details about the system information.

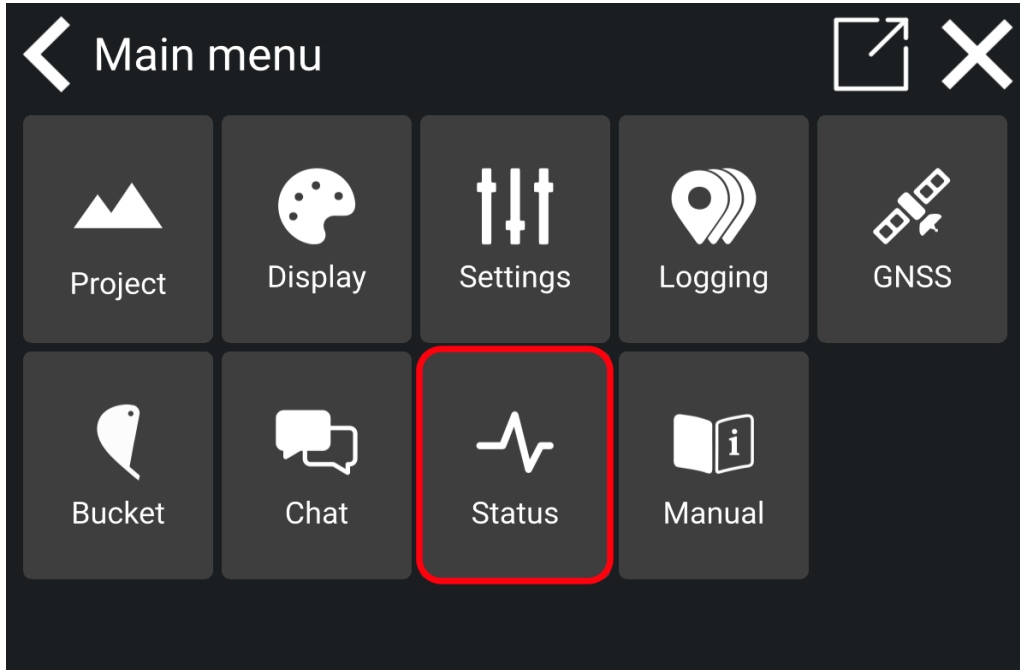

- Tap 'GNSS' to see the connection status and your location.
- Tap 'Sensors' to see detailed sensor information.
- 'Version' is the current Makin' 3D software version of the Android app running on your tablet.
- 'IB-1 version' is the firmware version of the interface box connecting all the sensors to the system.

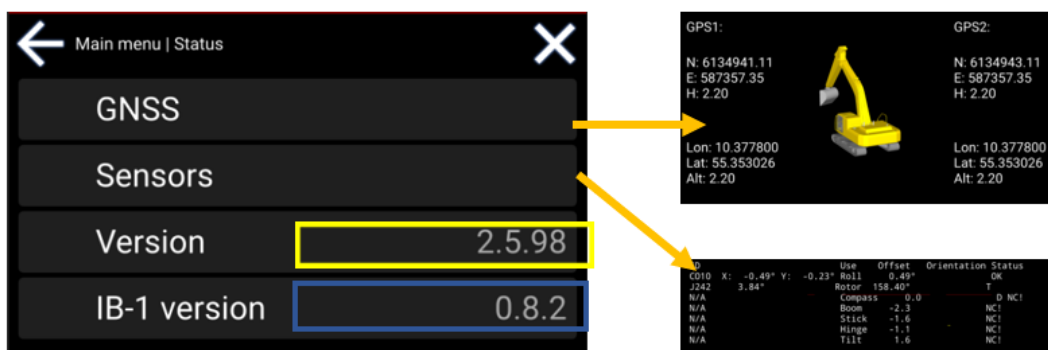

- **System info:** You can find all relevant information about your system by selecting 'System info'. Information such as System name, System number, System owner, and the associated licenses are shown here. When changes are made to the system, they will be shown under System info.

# 13. Calibration

## 13.1. Bucket calibration

Always place your machine on the most stable surface possible and read through the full chapter before starting.

### 13.1.1. Tools required

- Spirit level



- Tape measure



- Plumb bob or self-leveling point laser



### 13.1.2. Before calibrating the bucket

- For excavators with a swing boom, please ensure that the boom is aligned with the machine's centerline before any calibrations are performed.

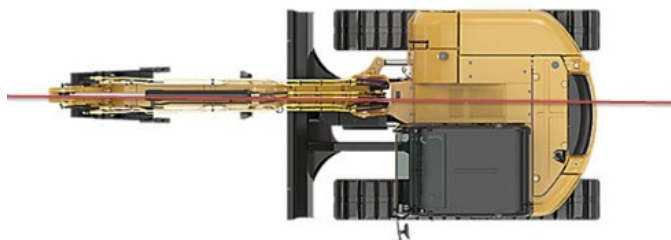

- For excavators with tilt rotators, please center the rotating device before bucket calibration.

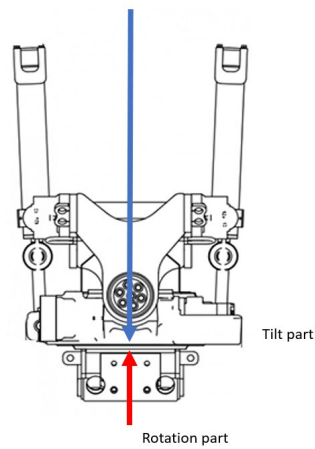

## 13.2. Bucket calibration menu

Go to the bucket menu from the main screen. See Chapter 10, *Bucket* for further details.

- 1) If you want to add a new bucket, tap the **plus symbol**.
- 2) Tap the bucket you want to calibrate.

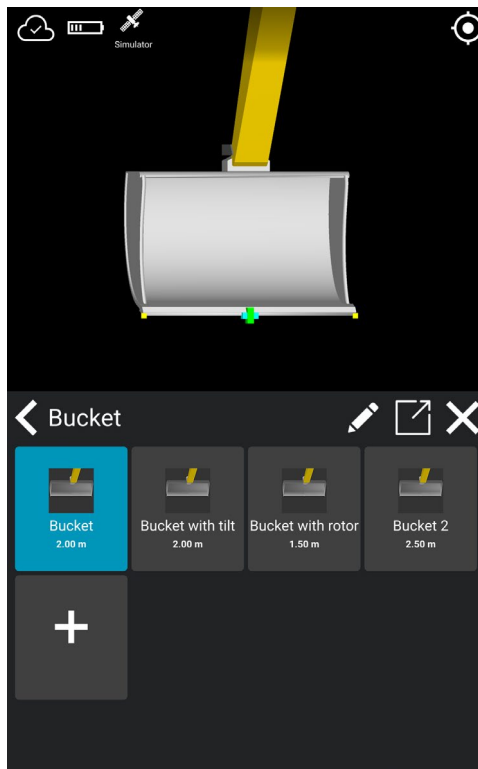

3) Tap the **pen icon** to begin calibrating.

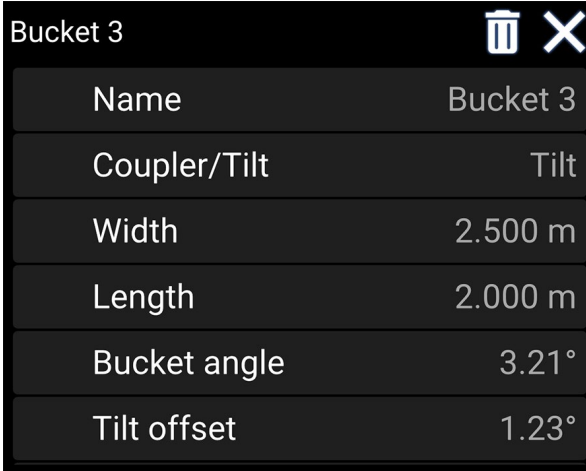

Bucket 3	
Name	Bucket 3
Coupler/Tilt	Tilt
Width	2.500 m
Length	2.000 m
Bucket angle	3.21°
Tilt offset	1.23°

### 13.2.1. Bucket name

In the bucket calibration, tap '**Name**' to edit the name of the bucket. Type the name and press the check mark to save.

### 13.2.2. Bucket tilt and quick coupler

This step is important to do before calibrating the bucket angle (see further below).

- 1) Tap '**Coupler/Tilt**' to state which application is present - i.e., None, Tilt, Rotortilt. If Rotortilt is present, the rotor must be in the center, as stated above under *Before calibrating the bucket*.
- 2) Tap '**Tilt offset**' if you have tilt installed. Tilt the bucket until the cutting edge is horizontal, using a spirit level. Then tap '**Reset**' and the check mark to save.



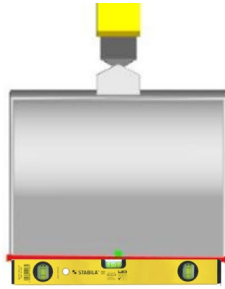

### 13.2.3. Bucket width

In the bucket calibration, tap **'Width'** to enter the width of the bucket. The width is the total working width of the bucket, which you get by measuring the cutting edge. Tap the question mark icon for a visual guide. Tap the check mark to save.

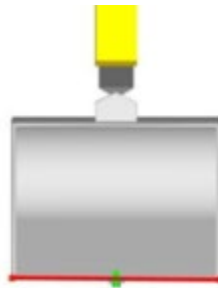

### 13.2.4. Bucket length

Tap **'Length'** to enter the length of the bucket. The length is measured from the center pivot point at the end of the stick to the bucket's cutting edge. Tap the question mark icon for a visual guide. Tap the check mark to save.



- If you have a tilt-rotor application, then measure the length from both the left and right sides of the stick pivot bolt to the cutting edge, as the tilt may not be dead center. Use the average of the two measurements and apply this as the bucket length.

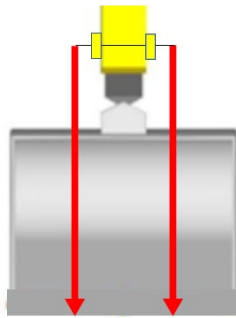

### 13.2.5. Bucket angle

- Please make sure you have followed the instructions under *Bucket tilt and Quick Coupler* above, before continuing to calibrate the bucket angle.
- Tap '**Bucket angle**'. Place the machine with the boom and stick at a height that allows you to open and close the bucket freely. Below, you will find two ways of calibrating the bucket angle: *Laser option* or *Plumb bob option*.

### 13.2.6. Tilt offset

See the description in *Bucket tilt and quick coupler* above.

### 13.2.7. Profile angle

- The bucket's profile angle is optional and for visualization purposes only.
- Tap '**Profile angle**' and type in the bucket's profile angle in the box. Tap the question mark icon for a visual guide. Tap the check mark to save.

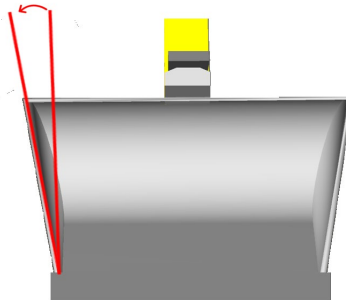

#### 13.2.7.1. Laser option

- 1) Place a self-leveling point laser on the machine frame, pointing towards the bucket center point. The bucket must be horizontal.
- 2) Open the bucket until the laser hits the center of the cutting edge. The more you can open and close the bucket, the better the calibration result.

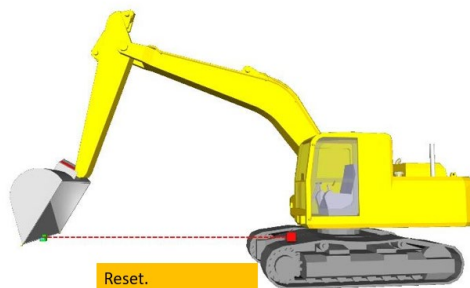

- 3) Tap '**Reset**'.
- 4) Now close the bucket until the laser hits the center of the cutting edge again.

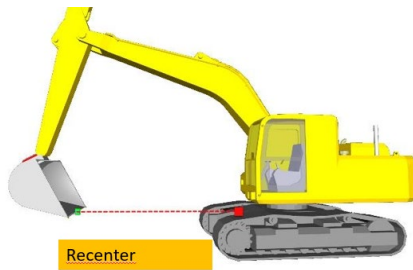

- 5) Tap '**Recenter**'.
- 6) Tap the check mark to save.

### 13.2.7.2. Plumb bob option

- 1) Place a magnet on the center of the stick's pivot bolt to hold the plumb bob line, and let it hang.
- 2) Then open the bucket if needed until the line is hanging free of the bucket.

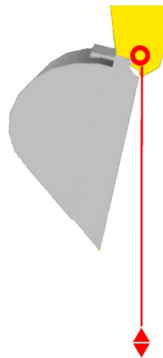

- 3) Close the bucket until the line just touches the cutting edge of the bucket.

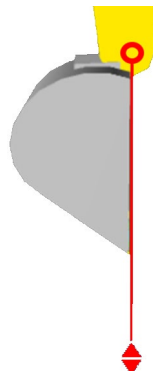

- 4) Tap **Reset** and the check mark to save.

### 13.2.8. Flat angle

- 1) Place a spirit level underneath the cutting edge of the bucket. Move the bucket so the cutting edge lies horizontally.

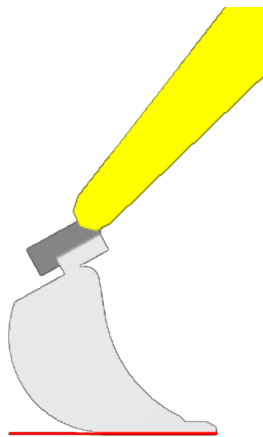

- 2) Press '**Reset**' if the bucket is horizontal.

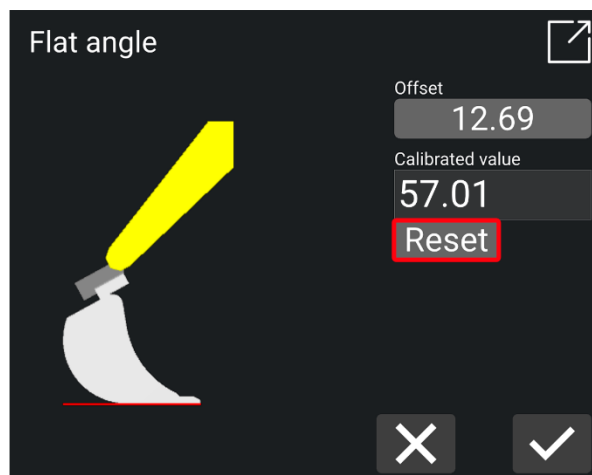

- 3) Click on the check mark to confirm the offset and calibrated value.

## 13.3. Check calibration of your excavator

Before you start your daily work, we advise that a calibration check should be performed.

Also, ensure that the machine you are going to operate is fully calibrated by a Makin' 3D specialist and that your current bucket is calibrated. Follow these steps:

- 1) You need a known point.
- 2) You need an operational GPS and correction signal with DOP as close to 1.0 or below as possible.
- 3) Place your open bucket with the cutting edge center horizontal on the point and check coordinates.
- 4) Then close the bucket and place the cutting edge center at the same known point.
- 5) If your reading is within a few centimeters of the target, your calibration is okay; otherwise, recalibrate.
- 6) If you have tilt/rotor tilt, check your calibration with full tilt and different rotation angles on both sides.

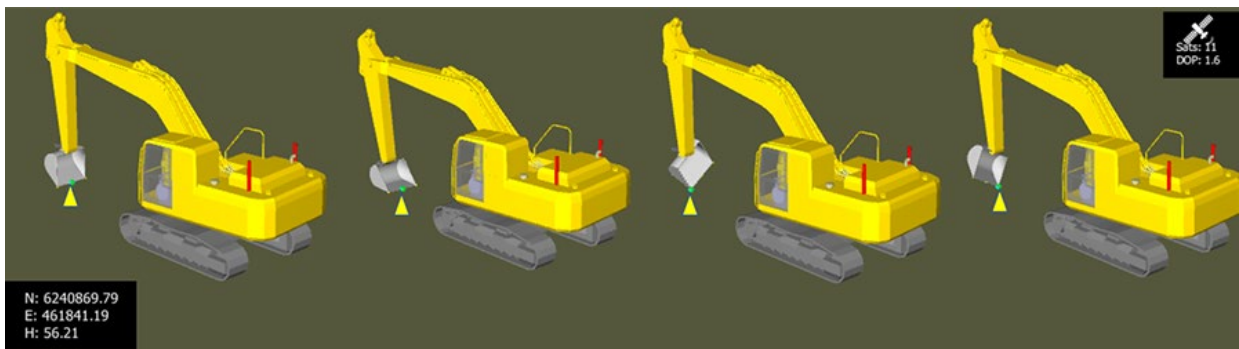

# 14. Makin' Surfaces

Makin' Surfaces enhances operator overview and efficiency through automatic as-built surface documentation and graphical visualization of project progress and completion status.

Logging is done in reference to the original ground level, OGL, which is defined in the project file, thus ensuring that only data logged below this level is used and visualized. With Makin' Surfaces, the operator will always log information about the true "bottom of cut".

The operator is continuously guided by a color-coded plot showing the bottom of the cut relative to the reference surface.

## 14.1. Create and edit layers for Makin' Surfaces on the tablet

Select the layer that you want to log the data to. Data will always be logged at the lowest level that has been dug, which is the 'Bottom' layer.

You can pause the logging in the layer by pressing the 'Pause' button on the layer. The logging will then automatically be logged in the 'Bottom' layer.

- 1) Press the Makin' Surfaces icon and select a layer. Press the '+' icon to add a new layer.

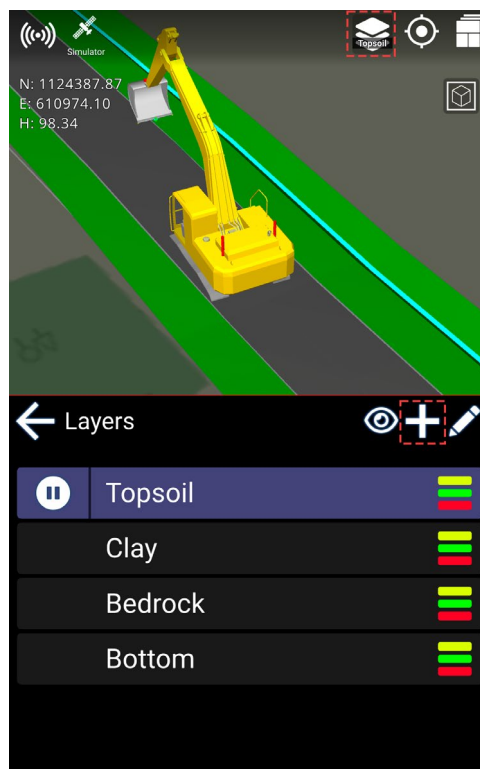

2) Place the new layer below or above the selected layer.

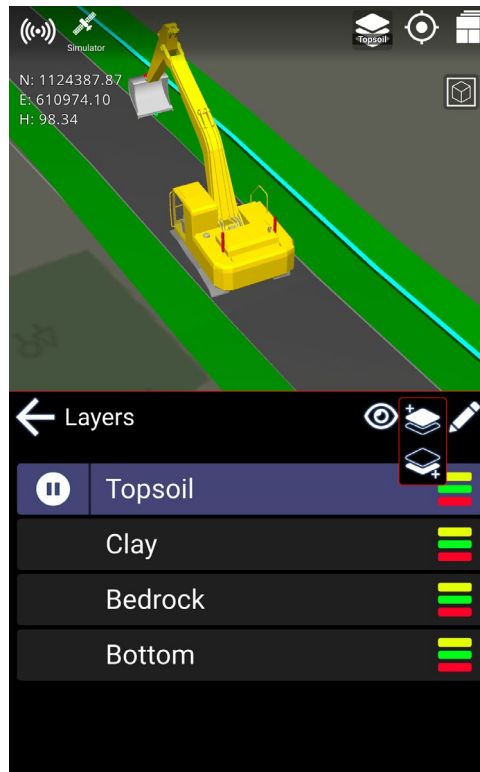

3) Enter the name of the new layer. In this case, it's called "Vegetation." Press **OK**.

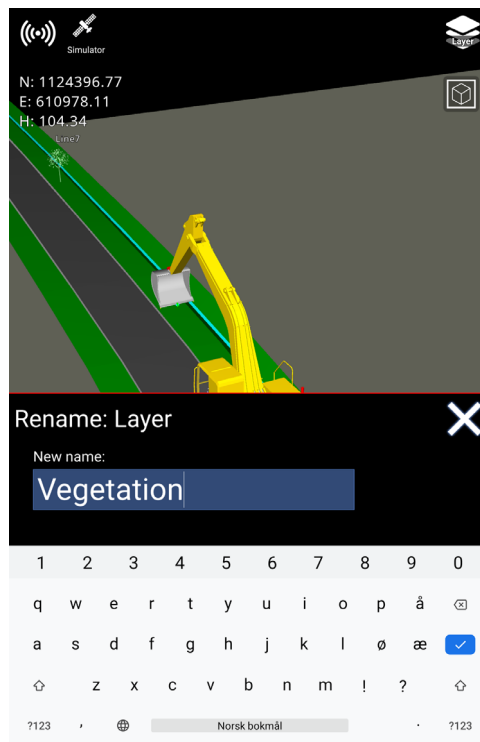



The color of the heat map is, by default, determined by the reference height.

The Makin' Surfaces heat map will be colored according to the height tolerance colors and will be updated when the height tolerances are changed.

When working outside the model, the coloring will be gray.

## 14.2. Change coloring from Reference height to Fixed

- 1) Press the icon for Makin' Surfaces. Press the pen icon to edit.
- 2) Select **Coloring** and change the coloring to a **fixed color**.

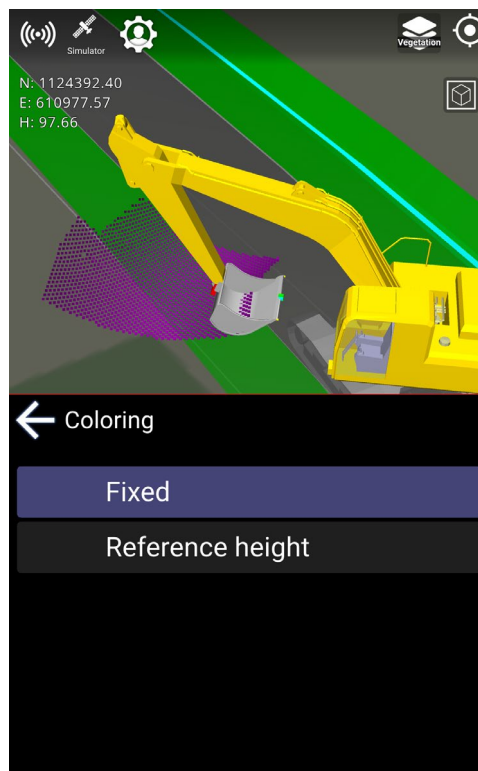

- 3) Select a color. Press **OK** to close the window.

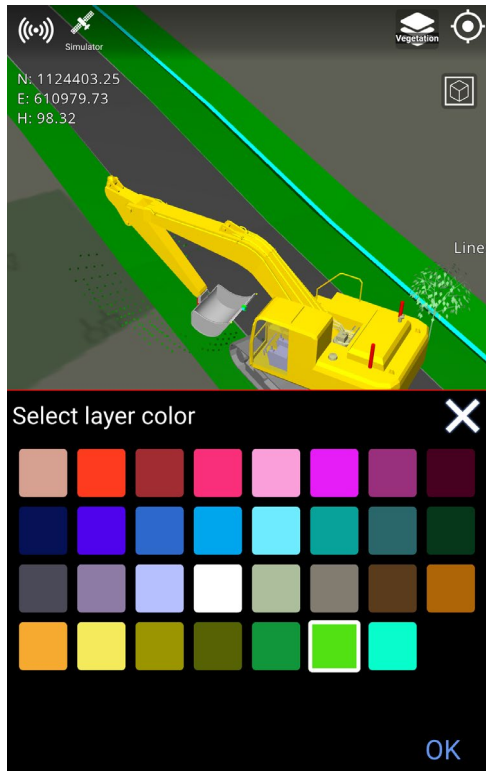

- 4) Press the arrow to close. The surface will now be colored with the selected color. When working outside the model, the color will have another tint.

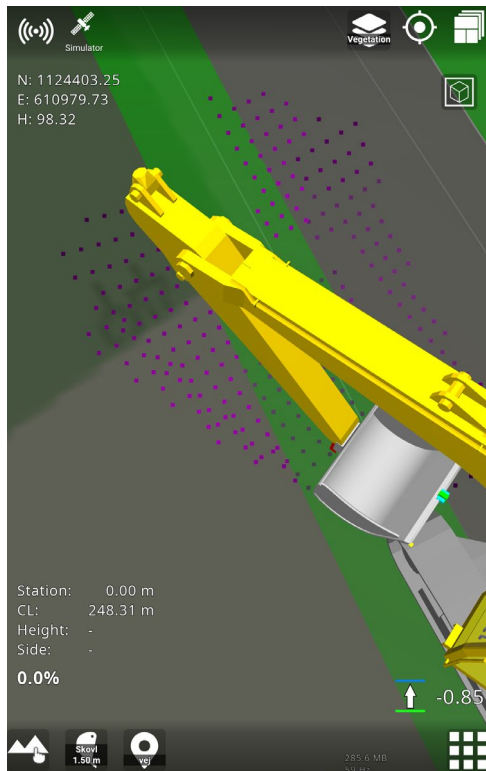

## 14.3. Hide the Makin' Surfaces layers

- 1) Hide the logging by pressing the **eye icon**. Press the arrow to close the window.

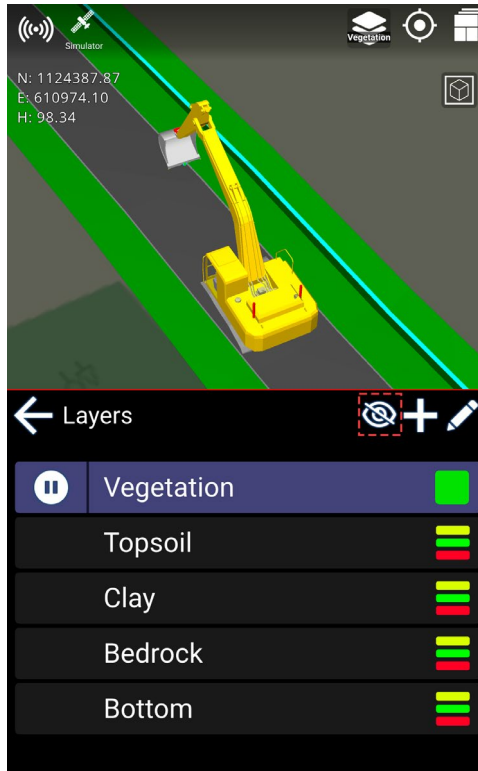

The logged surfaces will not be shown persistently on the screen but only transiently.

- 2) Press the eye icon to show the logged surfaces again.

## 14.4. Enhance the display of the Makin' Surfaces layers

- Long-hold on the Makin' Surfaces icon if you need to emphasize the surface for better visibility.

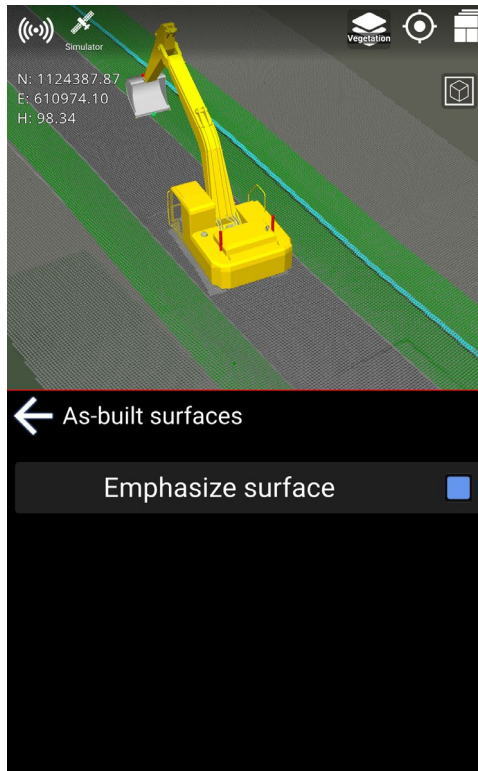

The surfaces will now be shown in a stronger color and with a denser point cloud.



# 16. Appendix

## 16.1. Software updates

When updating the Makin' 3D app to a new version, you might receive a notification from Google Play Protect. To proceed with the installation, allow Google Play Protect to scan the app. This ensures the new software version is safe to install.

- 1) Tap on '**Scan app**'.

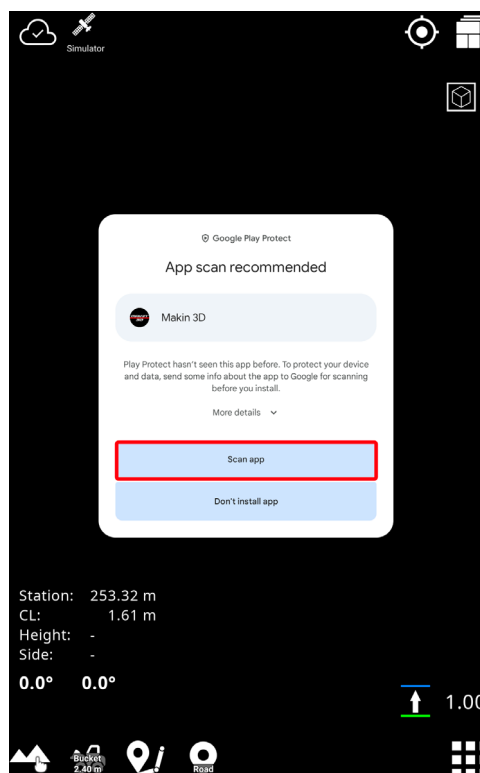

- 2) Tap '**Install**'.

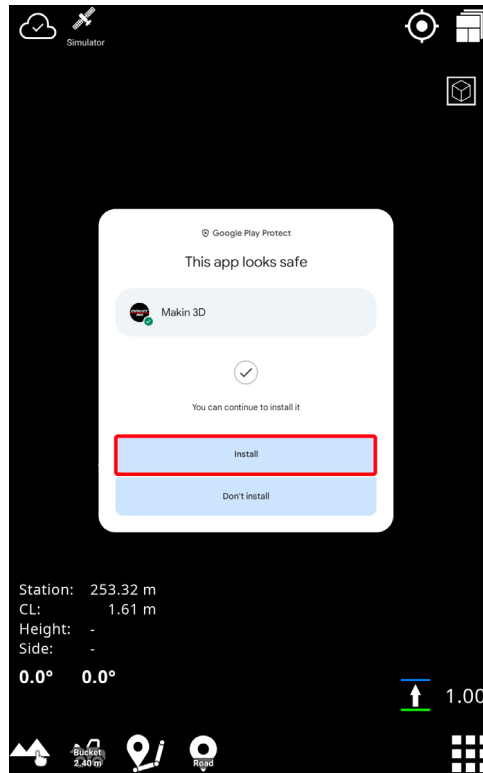

- 3) The Makin' 3D app is now updating to a new software version. Please wait while the update is installed.

## 16.2. GNSS limitations

Always take into consideration where your machine is located. Especially when the construction site is within city limits with tall buildings or other obstacles.

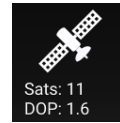

Also, if working near forest and mountain areas, interference could block the signal from one or more satellites and cause poor precision. Reflections could also occur.

Makin' 3D will inform you if there are not enough visible satellites or if your CQ/DOP is too high.

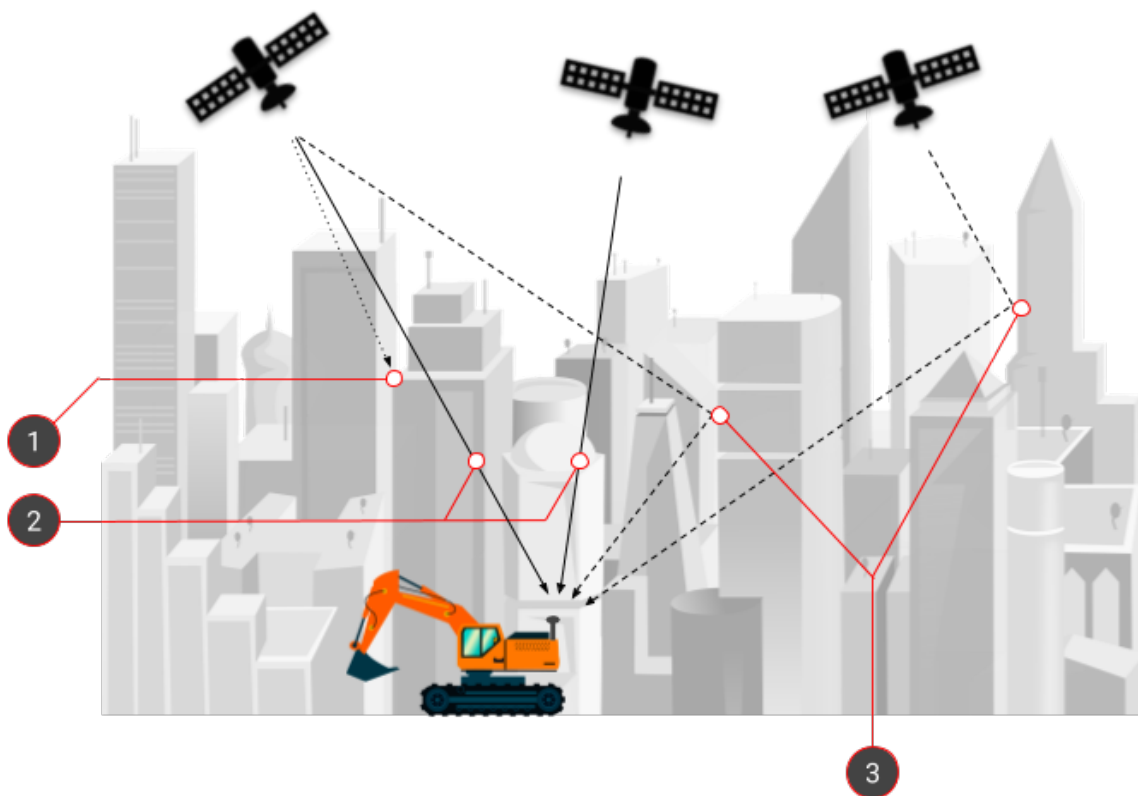

1. Direct signal blocked

3. Multipath errors

2. Direct signals perfectly received



## 16.3. Frequency

In situations where you have to specify the frequency according to a channel, refer to the table below for guidance. Channel 0 is the center frequency, and channels are distributed with a 25 kHz spacing (in this example).

<b>Channel</b>	<b>Frequency (MHz)</b>
0	446.6000
-1	446.5750
-4	446.5000
-5	446.4750

## 16.4. Compliance information

This product is intended to be mounted on earth-moving machinery exclusively for professional use, i.e. the product falls into the category: non-road vehicles exclusively for professional use. Makin hereby declares that the system and its components fulfill the requirements of the following EU directives applicable to this product category:

- 93/68/EEC - CE conformity marking
- 2014/53/EU - Radio Equipment Directive
- 2014/30/EU - EMC directive
  - DS/EN/ISO 13766-1:2018 - Earth-moving and building construction machinery – Electromagnetic compatibility (EMC) of machines with internal electrical power supply – Part 1: General EMC requirements under typical electromagnetic environmental conditions
  - DS/EN/ISO 13766-2:2018 - Earth-moving and building construction machinery – Electromagnetic compatibility (EMC) of machines with internal electrical power supply – Part 2: Additional EMC requirements for functional safety

The respective product category falls outside the scope of these directives:

- 2011/65/EU - RoHS
- 2012/19/EU - WEEE

## 16.5. Tablet connections

### 16.5.1. Tablet Panasonic FZ-A3 connections

The Panasonic FZ-A3 has connectors located in four places: on the top, on the side, inside the battery compartment, and at the bottom.



**1.** Mini-jack audio output

**2.** Micro SIM card for broadband internet on both tablet and GNSS receiver

**3.** Docking station connector for data and power transmission

**4.** 16 V DC input power for external charger

**5.** USB-A

**6.** USB-C

## 16.5.2. Tablet Panasonic FZ-A2 connections

The Panasonic FZ-A2 has connectors on the top, on the side, inside the battery compartment, and at the bottom.

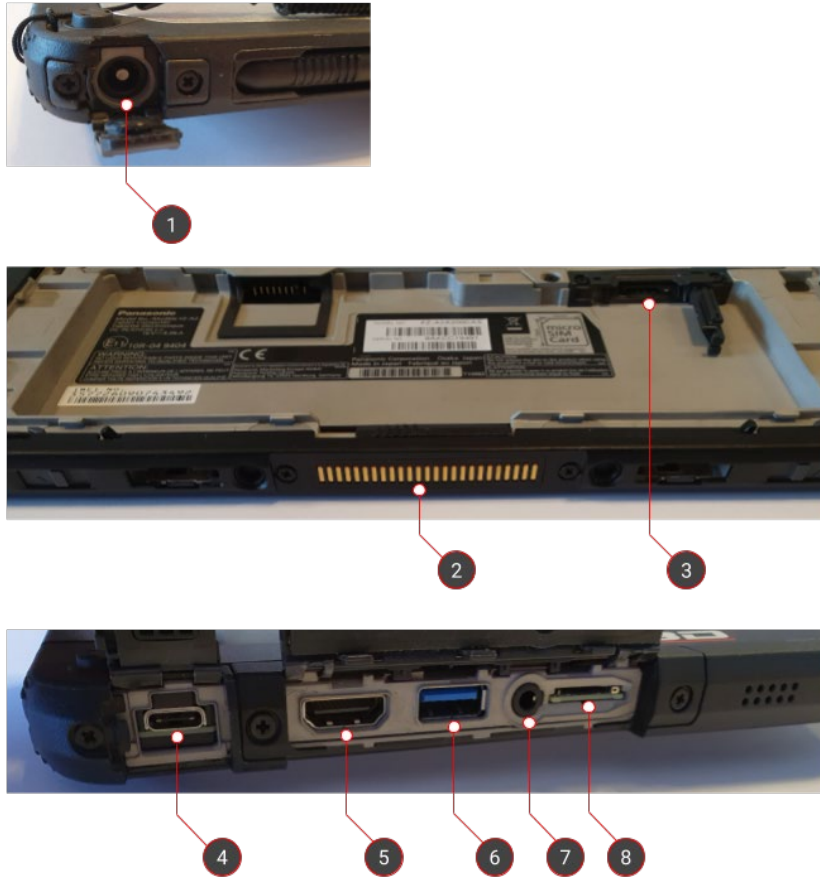

**1.** 16 V DC input power for external charger

**2.** Docking station connector for data and power transmission

**3.** Micro SIM card for broadband internet on both tablet and GNSS receiver

**4.** USB-C

**5.** HDMI output to external screen

**6.** SuperSpeed USB-A 3.0

**7.** Mini-jack audio output

**8.** Micro SD for extended storage

## 16.6. Docking station connections

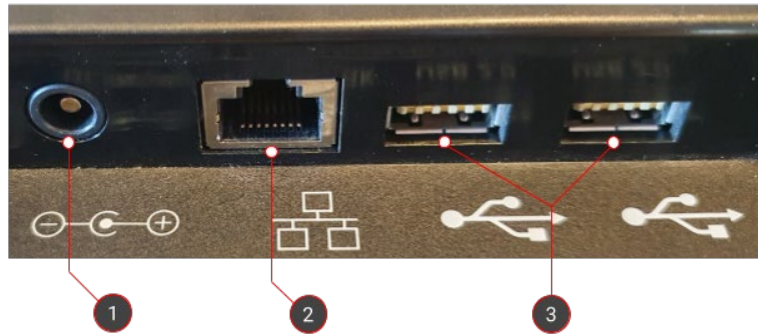

**1.** 16 V DC input power for external charger

**2.** RJ-45 Ethernet

**3.** 2x HighSpeed USB-A 2.0

## 16.7. Tablet set-up

### 16.7.1. Tablet buttons and light indicators (Panasonic FZ-A2)

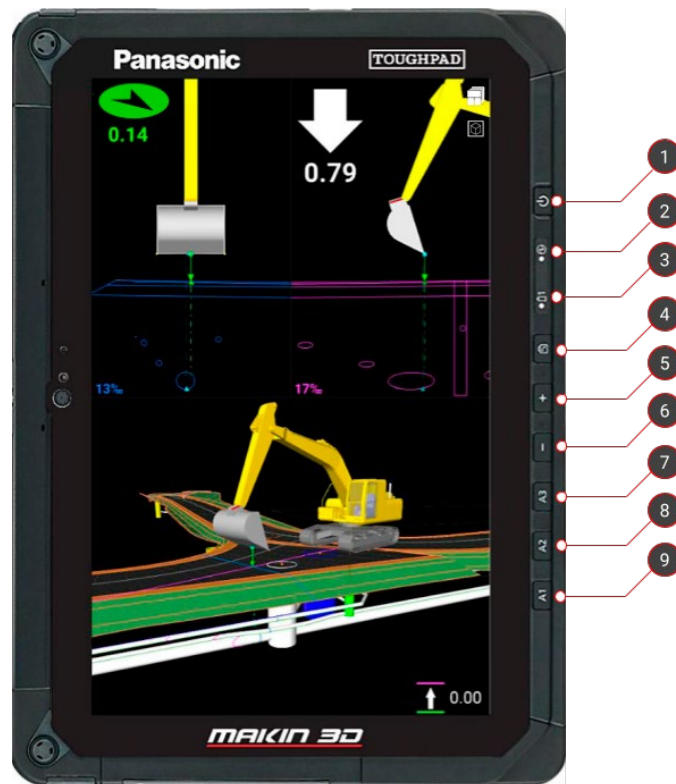

#### 1. On/Off button

#### 2. Power indicator

- *No light:* System is off
- *Green light:* System is on
- *Blinking green light:* Tablet in sleep mode

#### 3. Charging indicator

- *No light:* External power source not connected
- *Red light:* Battery power is critically low. External power source is not connected.
- *Orange light:* Tablet is currently charging
- *Green light:* Tablet fully charged

4. Auto-rotate screen. The button can be programmed (more info below).

#### 5. Volume up

#### 6. Volume down

7. Not in use. The button can be programmed (See section 16.7.2. below).

8. Not in use. The button can be programmed (See section 16.7.2. below).

9. Basic tablet functionality via the 'Dashboard' app. The button can be programmed (See section 16.7.2. below).

## **16.7.2. Programming the physical tablet buttons**

Through an app called 'UserButtonManager', some of the physical buttons of the tablet can be easily programmed. These are called A1, A2, A3 and Rotate Lock in the app and correspond respectively to buttons 9, 8, 7, and 4 mentioned above.

By default, A1 launches the 'Dashboard' app, and Rotate Lock toggles 'Auto-rotate'.

## 16.8. Interface Box (IB-1)

Status information on the interface module can be read out by watching the LED just next to the power connector.

<b>Color</b>	<b>Indication</b>
Green	ON - all ok
Flashing red	Firmware issue - contact reseller
White	System check of software
Blue	Updates to software are ongoing



## 16.9. Demo mode

You can use your Makin' 3D system on Windows in demo mode to gain confidence in the user interface.

Please find below the shortcuts for the functions.

<b>Keyboard</b>	<b>Function</b>
j	Jump to near the project
J	Jump to the roundabout in Odense S
n/N	Move forward/backward
b/B	Turn to the left/right
m/M	Turn to the right/left
space	Start/stop automatic driving
s/S	Move forward/backward on the centerline
+/-	Raise machine/lower machine
r	View of screen and machine back to default
u	Jump to current side reference
1...8	Move the machine parts. Holding down ALT together reverses the movements.
1	Roll

2	Pitch
3	Rotate tracks
4	Boom
5	Stick
6	Bucket
7	Tilt
8	Rotor

## 16.10. Xbox controller

You can use an Xbox controller to navigate the excavator in the Makin' 3D system on your tablet. It is an easy way to gain confidence in the user interface. This feature is only available when you connect the Xbox controller to a Panasonic FZ-A3 tablet. Please note that you can also navigate the Survey and the PerFormans in the Makin' 3D system on the tablet, but you can only move around with the application and go to side references (*use button directions 1 and 5 for this; see picture below*).

### How to connect the Xbox controller to your tablet:

- 1) Go to **Settings** on your tablet.
- 2) Click on '**Connected devices**'.
- 3) Press the connect button on the Xbox controller on top of the controller (*between button number 2 and 4. See picture below*).
- 4) Click on '**Pair new device**'.
- 5) Click on the available Xbox Wireless Controller on the tablet screen. Wait for the devices to pair.
- 6) Your Xbox controller is now connected to the tablet and ready for use.

### How to use:

You can switch between **Dig mode** and **Drive mode** on your Xbox controller. Please find below the instructions for the button functions.

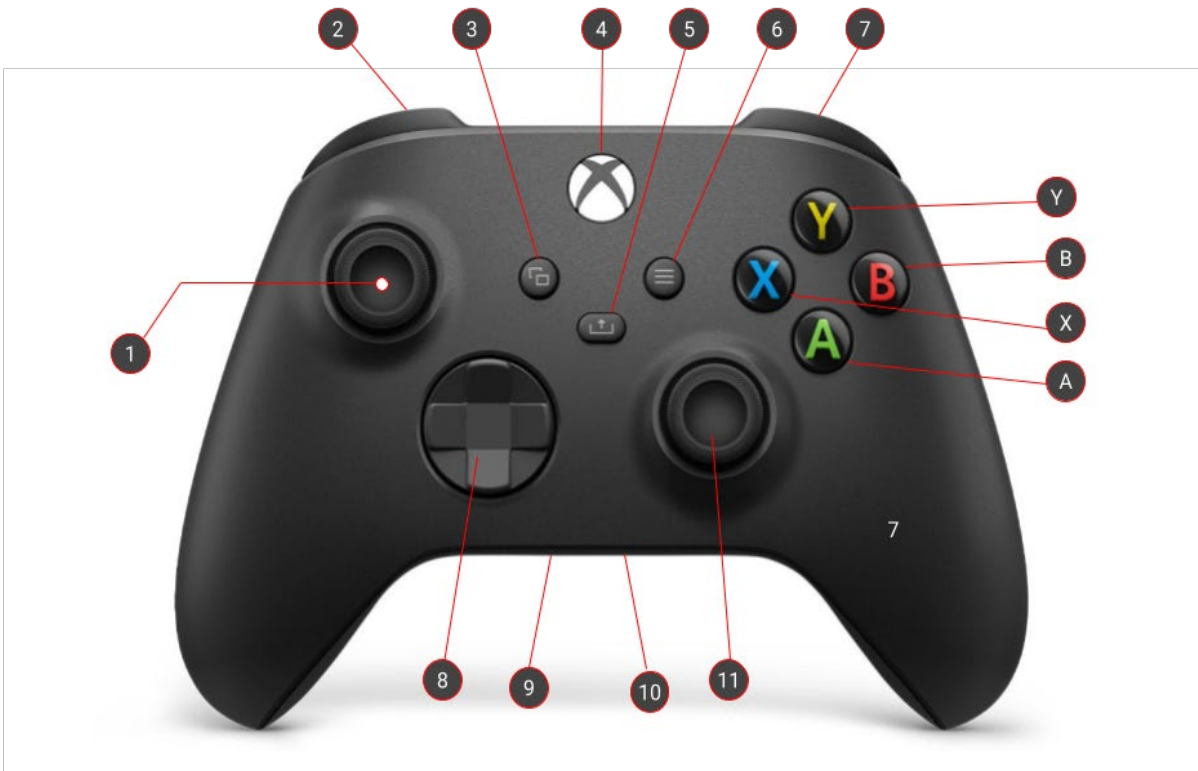

Button direction	Dig mode	Drive mode
1 Press down	Switch to drive mode	Switch to dig mode
1 Forward	Arm out	Drive forward
1 Backwards	Arm in	Drive backwards
1 left	Swing left	Turn machine left
1 right	Swing right	Turn machine right
2	Tilt left	Decrease turbo (stepwise)
3	-	-
4	Power on/off	
5	Jump to side reference	
6	-	-

7	Tilt right	Increase turbo (stepwise)
8	-	-
9	-	-
10	-	-
11 forward	Boom down	Pitch machine down
11 backwards	Boom up	Pitch machine up
11 left	Close bucket	Roll machine left
11 right	Open bucket	Roll machine right
A	Move machine down to 1 meter	
B	Rotate bucket right	
X	Rotate bucket left	
Y	Move machine up 1 meter	