

Tiltrotator EC209

Suitable for all excavators in the 6–9 tonne weight class

A compact, powerful tiltrotator with low weight for excavators up to 9 tons. If the EC209 is selected with engcon's standard quick hitch S45 and the proportional control system DC2, EC-Oil is offered an automatic quick hitch system as a free standard** This means that the tiltrotator and hydraulic tools can be connected & disconnected without the operator needing to leave the cab.

Comes supplied with hose, quick couplings and electrical installation equipment for one machine.

Advantages:

- » The EC-Oil automatic quick hitch system connects the tiltrotator & hydraulic tools without the operator needing to leave the cab**
- » Q-Safe quick hitch for maximum safety
- » Comes ready for detachable gripper GRD (S45)
- » Comes ready for sweeper SWD (S45)
- » Comes ready for the QSC locking system to avoid wrongly connected or dropped buckets
- » Comes ready for a rotation sensor (ePS) for connection to the excavator guidance system
- » Central lubrication (a single grease point for the entire tiltrotator; can also be connected to the excavator's central lubrication system)
- » Load-holding valves on tilt cylinders for maximum safety
- » Hardened piston rods
- » Up to ± 45 -degree tilt angle for best access
- » Rotation ∞

Quick hitch: Standard –S45.

Control system: Standard – DC2 proportional control system for infinitely variable control with remote support capability, track/wheel steering and boom slew. For other purposes, we can deliver custom control systems.

Electrical system: Can be adapted for 12 or 24 volt electrical systems.

Accessory: GRD detachable gripper cassette*, SWD detachable sweeper*.

* Read more about the GRD at engcon.com

** Read more about the terms and conditions concerning the EC-Oil automatic quick hitch system as a free standard at engcon.com



Specifications

Type	EC209
Width A: (mm)*	277
Width B: (mm)*	250
Width C: (mm)*	273
Length overall D: (mm)*	561
Construction height E: (mm)*	from 425
Weight: (kg)*	332
Tilt:	2x45°
Rec. hydraulic flow DC2/SS10 (l/min):	60
Rec. hydraulic flow SS9 tilt/rotation: (l/min):	35/40
Max hydraulic pressure: (MPa)	22
Quick hitch standard:	S45
Max bucket width rec. by Engcon: (mm)	1,300
Max breakout torque: (kNm)	74
Base machine weight: (t)	6–9

*Standard attachment

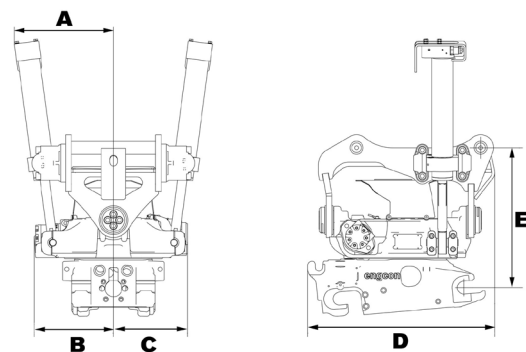

CHANGE THE WORLD OF DIGGING